

OXO Connect 2.1

8078s Premium Deskphone
8068s Premium Deskphone
8058s Premium Deskphone
8028s Premium Deskphone

User Manual

8AL90340ENAAed01-1712



Introduction

Thank you for choosing an ALE International phone.

This model offers enhanced ergonomical features for more effective communication.

This document describes the services offered by the following sets:

- Alcatel-Lucent 8078s Bluetooth® Premium Deskphone (8078s BT).
- Alcatel-Lucent 8078s Premium Deskphone (8078s).
- Alcatel-Lucent 8068s Bluetooth® Premium Deskphone (8068s BT).
- Alcatel-Lucent 8068s Premium Deskphone (8068s).
- Alcatel-Lucent 8058s Premium Deskphone (8058s).
- Alcatel-Lucent 8028s Premium Deskphone (8028s).

The label and icons displayed depend on the type and the skin of the set. The label is not displayed if the corresponding feature is not configured on your telephone system. Depending on the size of the display, some labels may be truncated.

Some features depend on the type of the set.

	8078s BT	8078s	8068s BT	8068s	8058s	8028s
IP Phone	✓	✓	✓	✓	✓	✓
Color screen	✓	✓	✓	✓	✓	
Monochrome screen						✓
Busy light logo on back shell	✓	✓	✓	✓	✓	
Theme (skin)	✓	✓	✓	✓	✓	
Bluetooth® handset	✓		✓			
Bluetooth® Smart Ready	✓		✓			
Two-port Gigabit Ethernet switch with Power Over Ethernet support	✓	✓	✓	✓	✓	✓
Premium Add-on 10 keys modules			✓	✓	✓	✓
Premium Smart display 14 keys module	✓	✓	✓	✓	✓	✓
Premium add-on 40-key modules	✓	✓	✓	✓	✓	✓
Audio services (hands-free, handset and headset)	✓	✓	✓	✓	✓	✓
Adjusting the contrast of the display						✓
Ambient light sensor	✓	✓	✓	✓	✓	
Agent set / Supervisor station	✓	✓	✓	✓	✓	✓
Remote Worker	✓	✓	✓	✓	✓	✓

The labels and icons presented in this document are not contractually binding and may be modified without prior warning.

1	GETTING TO KNOW YOUR TELEPHONE.....	6
1.1	8078S BLUETOOTH/ 8078S PREMIUM DESKPHONE.....	6
1.2	8068S BLUETOOTH/ 8068S PREMIUM DESKPHONE.....	8
1.3	8058S PREMIUM DESKPHONE.....	10
1.4	8028S PREMIUM DESKPHONE.....	12
1.5	WELCOME SCREENS.....	14
1.6	USER LOCAL MENU.....	15
1.7	STATUS ICONS/ CALL ICONS.....	16
1.8	PERMANENT FEATURES KEYS.....	16
1.9	MAGNETIC ALPHABETIC KEYBOARD.....	17
1.10	DESCRIPTION OF THE CONNECTORS.....	18
1.11	ADD-ON MODULE.....	18
1.12	BLUETOOTH® WIRELESS HANDSET.....	22
1.13	INSTALLING A BLUETOOTH® WIRELESS TECHNOLOGY HANDSET (PAIRING).....	23
1.14	INSTALL A COMFORT WIRED HANDSET.....	24
2	USING YOUR TELEPHONE.....	25
2.1	MESSAGING PORTAL.....	25
2.2	CONSULTING THE CALL LOG.....	26
2.3	MAKING A CALL.....	28
2.4	RECEIVING A CALL.....	28
2.5	USING THE TELEPHONE IN 'HANDS FREE' MODE.....	29
2.6	ACTIVATING THE LOUDSPEAKER DURING A CONVERSATION (HANDSET LIFTED).....	29
2.7	CALLING A CONTACT USING THE SEARCH BY NAME FEATURE.....	29
2.8	MAKE CALLS VIA YOUR PROGRAMMED CALL KEYS (PERSO PAGE/F1 AND F2 KEYS/ADD-ON MODULE) ..	30
2.9	FILTERING CALLS USING THE VOICE MAILBOX.....	31
2.10	REDIALING.....	31
2.11	REQUESTING AUTOMATIC CALLBACK IF INTERNAL NUMBER IS BUSY.....	31
2.12	CANCELLING AN AUTOMATIC CALLBACK.....	31
2.13	RECEIVING INTERCOM CALLS.....	32
2.14	SENDING DTMF SIGNALS.....	32
2.15	MUTE, SO THAT YOUR CALLER CANNOT HEAR YOU.....	32
2.16	SENDING AN INSTANT MESSAGE TO A CONTACT.....	33
2.17	ANSWERING WITH AN INSTANT MESSAGE.....	34
2.18	CONSULTING INSTANT MESSAGES.....	35
3	DURING A CONVERSATION.....	36
3.1	MAKING A SECOND CALL DURING A CONVERSATION.....	36
3.2	ANSWERING A SECOND CALL DURING A CONVERSATION.....	37
3.3	SWITCHING BETWEEN CALLS (BROKER CALL).....	37
3.4	TRANSFERRING A CALL.....	37
3.5	TRANSFER A CALL TO A VOICE MAIL.....	38
3.6	THREE-WAY CONFERENCE WITH INTERNAL AND/OR EXTERNAL CALLERS (CONFERENCE).....	38
3.7	PLACING A CALL ON HOLD (HOLD).....	38
3.8	PLACING AN OUTSIDE CALL ON HOLD (PARKING).....	39
3.9	INTRUSION INTO AN INTERNAL CONVERSATION.....	39
3.10	STORE A NUMBER.....	39
3.11	ADJUST AUDIO VOLUME.....	39
4	'MEET ME' CONFERENCE.....	40

4.1	INITIATE A 'MEET ME' CONFERENCE	40
4.2	JOIN A 'MEET ME' CONFERENCE.....	40
5	SHARING.....	41
5.1	RECEIVING SUPERVISED CALL RINGING	41
5.2	ANSWERING THE GENERAL BELL	41
5.3	MANAGER/ASSISTANT FILTERING	41
5.4	CALL PICK-UP.....	41
5.5	OUTSIDE CALLS TO THE OPERATOR WILL RING ON YOUR TELEPHONE AND YOU CAN ANSWER THE CALL	42
5.6	HUNTING GROUPS.....	42
5.7	CALLING AN INTERNAL CALLER ON HIS/HER PAGER.....	42
5.8	ANSWERING A CALL ON YOUR PAGER	42
5.9	CALLING A CALLER ON HIS/HER LOUDSPEAKER	43
5.10	SEND A VOICE MESSAGE COPY	43
5.11	SENDING A RECORDED MESSAGE TO A NUMBER OR A DISTRIBUTION LIST.....	43
5.12	BROADCASTING A MESSAGE ON THE LOUDSPEAKERS OF A STATION GROUP	44
6	KEEP IN TOUCH	45
6.1	SELECTING CALLS TO BE FORWARDED	45
6.2	FORWARDING CALLS TO ANOTHER NUMBER (IMMEDIATE FORWARD).....	45
6.3	FORWARDING YOUR CALLS TO YOUR VOICE MESSAGE SERVICE	45
6.4	WHEN YOU RETURN, CONSULT RECORDED MESSAGES.....	45
6.5	ACTIVATE/DISABLE THE PERSONAL ASSISTANT.....	46
6.6	PERSONAL ASSISTANT: REACHING YOU WITH ONE NUMBER ONLY	46
6.7	FORWARDING CALLS TO YOUR PAGER	46
6.8	FORWARDING YOUR CALLS FROM THE RECEIVING TERMINAL ('FOLLOW ME').....	47
6.9	DIVERTING ALL GROUP CALLS	47
6.10	CANCELLING ALL FORWARDS	47
6.11	CANCELLING A SPECIFIC FORWARD	47
6.12	FORWARDING CALLS WHEN YOUR LINE IS BUSY (FORWARD IF BUSY).....	47
6.13	DO NOT DISTURB	48
6.14	LEAVING A RECORDED MESSAGE FOR INTERNAL CALLERS.....	48
6.15	CONSULTING WRITTEN MESSAGES.....	49
6.16	MESSAGE NOTIFICATION.....	49
7	PROGRAMMING YOUR TELEPHONE	50
7.1	INITIALIZING YOUR VOICE MAILBOX.....	50
7.2	CUSTOMIZING YOUR VOICE GREETING	50
7.3	MODIFYING YOUR PERSONAL CODE	50
7.4	ADJUSTING THE AUDIO FUNCTIONS	51
7.5	ADJUSTING THE BRIGHTNESS OF THE DESKPHONE.....	52
7.6	SELECTING THE WELCOME PAGE	52
7.7	SELECTING LANGUAGE	53
7.8	PROGRAMMING DIRECT CALL KEYS (PERSO PAGE/F1 AND F2 KEYS/ADD-ON MODULE).....	53
7.9	MODIFYING DIRECT CALL KEYS	53
7.10	DELETING DIRECT CALL KEYS	54
7.11	PROGRAMMING AN APPOINTMENT REMINDER	54
7.12	IDENTIFY THE TERMINAL YOU ARE ON.....	54
7.13	LOCK / UNLOCK YOUR TELEPHONE	54
7.14	INSTALL A JACK ACCESSORY (HEADSET, HANDSFREE, LOUDSPEAKER).....	55

7.15	ACTIVATING/DEACTIVATING 'FORCED HEADSET' MODE	55
7.16	INSTALLING A BLUETOOTH® WIRELESS TECHNOLOGY HANDSET (PAIRING)	55
7.17	USE OF THE BLUETOOTH® HANDSET	56
7.18	INSTALLING A BLUETOOTH® WIRELESS TECHNOLOGY HEADSET (PAIRING)	57
7.19	USING A BLUETOOTH® WIRELESS TECHNOLOGY HEADSET	57
7.20	DISPLAY ALL PAIRED BLUETOOTH DEVICES	57
7.21	REMOVING A BLUETOOTH ACCESSORY (HEADSET, HANDSET, ETC.)	58
7.22	PAIR YOUR PHONE AS A BLUETOOTH DEVICE	58
7.23	CONFIGURE YOUR PHONE FOR TELEWORKING.....	58
7.24	CONTACTING YOUR ADMINISTRATOR.....	62
8	<u>ACD: AGENT SET/ SUPERVISOR STATION.....</u>	63
8.1	AGENT SET	63
8.2	OPEN AN AGENT SESSION (LOGIN) – AGENT SET	63
8.3	ACD APPLICATION WELCOME SCREEN – AGENT SET	63
8.4	THE FOUR OPERATING STATUSES OF THE AGENT SET	64
8.5	CHANGING THE OPERATING STATUS OF THE SET – AGENT SET.....	64
8.6	MODIFYING YOUR PERSONAL CODE – AGENT SET	64
8.7	INTEGRATING ANOTHER GROUP/LEAVING A GROUP – AGENT SET.....	64
8.8	CLOSE THE AGENT SESSION (LOGOUT) – AGENT SET	64
8.9	SUPERVISOR STATION	64
8.10	SUPERVISING GROUP MAILBOXES – SUPERVISOR STATION	65
9	<u>ACCESSORIES</u>	66
9.1	HEADSETS.....	66
9.2	CONFERENCE MODULE	66
9.3	EHS INTERFACE	66
10	<u>GUARANTEE AND CLAUSES.....</u>	67
10.1	SAFETY INSTRUCTIONS.....	67
10.2	REGULATORY STATEMENTS	68

The labels and icons presented in this document are not contractually binding and may be modified without prior warning.

Copyright© ALE International 2017

1 Getting to know your telephone

1.1 8078s Bluetooth/ 8078s Premium Deskphone

This phone is part of the IP phone range. With its 5-inch color touchscreen display, the 8078s Premium DeskPhone delivers a great user experience and great conversation convenience with an outstanding audio quality in either hands-free mode or using the comfort handset. Additionally, the 8078s Bluetooth Premium DeskPhone improves your experience with its Bluetooth handset or other Bluetooth accessories. The 8078s Bluetooth Premium DeskPhone is 'Bluetooth Smart Ready'. You can personalize the phone by selecting a theme (skin). It is compatible with teleworking. Consequently, it is perfect for use at your office in your enterprise or at home (teleworking).

1.1.1 Phone description



- 1 LED**
 - Flashing blue: incoming call Arrival of a new call.
 - Flashing orange: alarm.
- 2** Color touchscreen display with auto brightness adjustment which improves the user experience and achieves power savings (ambient light sensor).
- 3** Permanent feature keys: quick access to the phone's main features.
- 4**
 - Bluetooth® wireless handset (8078s BT).
 - Wired handset.
- 5** 3.5 mm, 4 pole jack (international standard L-R-MIC-GND, European standard L-R-GND-MIC).
- 6** Magnetic alphabetic keyboard.
- 7** An adjustable and stable foot.
- 8** Loudspeaker.

1.1.2 Main screen

Date and time

Display the page by selecting the corresponding tab.

Navigation softkeys and quick access to specific settings

Date and time

Thu 09 Feb 2017 14:12

menu perso info > ↗

Line ↑ BlkDial

Line ↓ John

Line Clara

Line Pierre

⚙️ ⏪ OK ⏩

Forward icon.

Softkeys: Menus and actions available depending on the selected page.

	Select a page by pressing the corresponding tab on the screen. The selected page is highlighted. Make your selection by pressing the label on the screen.
	Scroll a list (features, call log, contact, ...) by pressing the up and down arrow on the screen, or on the keyboard.
	Manage your call forwarding by pressing the forward icon. <ul style="list-style-type: none"> • Stationary arrow: No forwarding activated. • Blinking arrow: Forwarding activated.
OK	Use the 'OK' softkey to validate your choices and options while programming or configuring.
⏪	Use the 'Back/Exit' icon to go back to the previous step.
⚙️	Use the 'Setting' icon for quick access to the user local menu.
📶	Use the 'Bluetooth' icon to open Bluetooth settings.

1.1.3 Call management screen



Each tab corresponds to a call, the status of which is symbolized by its icon (in progress, call on hold, arrival of new call). When a call is in progress, press on the corresponding tab to look at calls on hold or incoming calls.



All features are accessible while the call is displayed on the screen. Use the Up and Down arrows to move up or down a page. These functions (transfer, conference, etc.) are directly related to the status of the call consulted. For example, the transfer function will not be available between a call in progress or a call on hold and an incoming call.



Used to switch from a telephone screen to an application screen. For example, it can be used while a call is in progress to search a number, program an appointment reminder, etc.



Calls can also be managed from the Perso page. While the call is in progress, press the Back/Exit key and display the Perso page. Calls in progress or waiting calls are displayed on the different line keys. It is then possible to converse with the caller of your choice by pressing the key associated to the caller.

1.1.4 Access to the user local menu



or (long press) › Open the user local menu: *Audio, Display, Bluetooth, Skin* (See: User local menu).

1.1.5 Change the theme (skin) of your phone



- The phone is in idle state.
 -  or  (long press) › *Skin*
 - Select the desired new theme from the list.
 - 
- Changing the theme may take a few seconds.



A corporate theme can be installed by your administrator. In this case, you cannot change the theme. The ringtone settings can be integrated into a theme.

1.1.6 Busy light logo on back shell

The logo on back shell can be illuminated. The color changes when you are busy.

- The phone is in idle state.
-  or  (long press) › *Display* › *Advanced* › *Busy light*
- Activate or deactivate the logo LED feature.
- 



1.1.7 Bluetooth Smart Ready



Your phone is 'Bluetooth Smart Ready'. It can receive and share Bluetooth signals from various Bluetooth devices (Bluetooth and Bluetooth Smart or Low-energy devices). It is ready for future services available on the fly in a subsequent software upgrade.

1.2 8068s Bluetooth/ 8068s Premium Deskphone

This phone is part of the IP phone range. With its color display associated to 10 dedicated functions keys, and an intuitive navigation key, the 8068s Premium DeskPhone delivers a great user experience and great conversation convenience with an outstanding audio quality in either hands-free mode or using the comfort handset. Additionally, the 8068s Bluetooth Premium DeskPhone improves your experience with its Bluetooth handset or other Bluetooth accessories. The 8068s Bluetooth Premium DeskPhone is 'Bluetooth Smart Ready'. You can personalize the phone by selecting a theme (skin). It is compatible with teleworking. Consequently, it is perfect for use at your office in your enterprise or at home (teleworking).

1.2.1 Phone description



- 1 LED**
 - Flashing blue: incoming call Arrival of a new call.
 - Flashing orange: alarm.
- 2** Color touchscreen display with auto brightness adjustment which improves the user experience and achieves power savings (ambient light sensor).
- 3** 10 dedicated functions keys.
- 4** Navigation.
- 5** Permanent feature keys: quick access to the phone's main features.
- 6**
 - Bluetooth® wireless handset (8068s BT).
 - Wired handset.
- 7** 3.5 mm, 4 pole jack (international standard L-R-MIC-GND, European standard L-R-GND-MIC).
- 8** Magnetic alphabetic keyboard.
- 9** An adjustable and stable foot.
- 10** Loudspeaker.

1.2.2 Main screen

Date and time

Display the page by selecting the corresponding tab.

Forward icon.

Softkeys: Menus and actions available depending on the selected page.

- Ok key:** use to validate your choices and options while programming or configuring.
- Left-right navigator:** use to move from one page to another and display information about current calls (call in progress, calls on hold, incoming call).
- Up-down navigator:** use to scroll through the content of a page.
- Back/exit key:** use this key to go back to the previous step. Use this key to go back to the homepage (long press).
- Manage your call forwarding by pressing the key associated with the forward icon.
 - stationary arrow: no forwarding activated.
 - blinking arrow: forwarding activated.

1.2.3 Call management screen



Each tab corresponds to a call, the status of which is symbolized by its icon (in progress, call on hold, arrival of new call). When a call is in progress, use the left-right navigator to look at calls on hold or incoming calls.



All features are accessible while the call is displayed on the screen. Use the Up and Down arrows to move up or down a page. These functions (transfer, conference, etc.) are directly related to the status of the call consulted. For example, the transfer function will not be available between a call in progress or a call on hold and an incoming call.



Used to switch from a telephone screen to an application screen. For example, it can be used while a call is in progress to search a number, program an appointment reminder, etc

Calls can also be managed from the Perso page. While the call is in progress, press the Back/Exit key and display the Perso page. Calls in progress or waiting calls are displayed on the different line keys. It is then possible to converse with the caller of your choice by pressing the key associated to the caller.

1.2.4 Access to the user local menu



(long press) › Open the user local menu: *Audio, Display, Bluetooth, Skin* (See: User local menu).

1.2.5 Change the theme (skin) of your phone

- The phone is in idle state.
 - (long press) › *Skin*
 - Select the desired new theme from the list.
 -
- Changing the theme may take a few seconds.



A corporate theme can be installed by your administrator. In this case, you cannot change the theme. The ringtone settings can be integrated into a theme.

1.2.6 Busy light logo on back shell

The logo on back shell can be illuminated. The color changes when you are busy.

- The phone is in idle state.
- (long press) › *Display* › *Advanced* › *Busy light*
- Activate or deactivate the logo LED feature.
-



1.2.7 Bluetooth Smart Ready



You phone is 'Bluetooth Smart Ready'. It can receive and share Bluetooth signals from various Bluetooth devices (Bluetooth and Bluetooth Smart or Low-energy devices). It is ready for future services available on the fly in a subsequent software upgrade.

1.3 8058s Premium Deskphone

This phone is part of the IP phone range. In addition to a color display associated to 6 dedicated function keys and an intuitive navigation key, the 8058s Premium DeskPhone provides 4 programmable softkeys as a smart add-on module, for a quick access to your favorite contacts or features. It provides high audio fidelity for telephone calls either in hands-free mode or using the comfort handset. You can personalize the phone by selecting a theme (skin). It is compatible with teleworking. Consequently, it is perfect for use at your office in your enterprise or at home (teleworking).

1.3.1 Phone description



- 1 LED**
 - Flashing blue: incoming call Arrival of a new call.
 - Flashing orange: alarm.
- 2** Color touchscreen display with auto brightness adjustment which improves the user experience and achieves power savings (ambient light sensor).
- 3** 6 dedicated functions keys.
- 4** 4 programmable softkeys with LED.
- 5** Navigation.
- 6** Permanent feature keys: quick access to the phone's main features.
- 7** Wired handset.
- 8** 3.5 mm, 4 pole jack (international standard L-R-MIC-GND, European standard L-R-GND-MIC).
- 9** Magnetic alphabetic keyboard.
- 10** An adjustable and stable foot.
- 11** Loudspeaker.

1.3.2 Main screen

Date and time

Display the page by selecting the corresponding tab.

Programmable softkeys

Forward icon.

Softkeys: Menus and actions available depending on the selected page.

- Ok key:** use to validate your choices and options while programming or configuring.
- Left-right navigator:** use to move from one page to another and display information about current calls (call in progress, calls on hold, incoming call).
- Up-down navigator:** use to scroll through the content of a page.
- Back/exit key:** use this key to go back to the previous step. Use this key to go back to the homepage (long press).
- Manage your call forwarding by pressing the key associated with the forward icon.
 - stationary arrow: no forwarding activated.
 - blinking arrow: forwarding activated.

1.3.3 Call management screen



Each tab corresponds to a call, the status of which is symbolized by its icon (in progress, call on hold, arrival of new call). When a call is in progress, use the left-right navigator to look at calls on hold or incoming calls.



All features are accessible while the call is displayed on the screen. Use the Up and Down arrows to move up or down a page. These functions (transfer, conference, etc.) are directly related to the status of the call consulted. For example, the transfer function will not be available between a call in progress or a call on hold and an incoming call.



Used to switch from a telephone screen to an application screen. For example, it can be used while a call is in progress to search a number, program an appointment reminder, etc



Calls can also be managed from the Perso page. While the call is in progress, press the Back/Exit key and display the Perso page. Calls in progress or waiting calls are displayed on the different line keys. It is then possible to converse with the caller of your choice by pressing the key associated to the caller.

1.3.4 Access to the user local menu



(long press) › Open the user local menu: *Audio, Display, Skin* (See: User local menu).

1.3.5 Change the theme (skin) of your phone

- The phone is in idle state.
 -  (long press) › *Skin*
 - Select the desired new theme from the list.
 - 
- Changing the theme may take a few seconds.



A corporate theme can be installed by your administrator. In this case, you cannot change the theme. The ringtone settings can be integrated into a theme.

1.3.6 Busy light logo on back shell

The logo on back shell can be illuminated. The color changes when you are busy.

- The phone is in idle state.
-  (long press) › *Display* › *Advanced* › *Busy light*
- Activate or deactivate the logo LED feature.
- 



1.4 8028s Premium Deskphone

This phone is part of the IP phone range. In addition to a clear monochrome display associated to 6 dedicated function keys and an intuitive navigation key, the 8028s Premium DeskPhone provides 4 programmable keys as a smart add-on module, for a quick access to your favorite contacts or features. It provides high audio fidelity for telephone calls either in hands-free mode or using the comfort handset. It is compatible with teleworking. Consequently, it is perfect for use at your office in your enterprise or at home (teleworking).

1.4.1 Phone description



- 1 LED**
 - Flashing blue: incoming call Arrival of a new call.
 - Flashing orange: alarm.
- 2** Monochrome screen.
- 3** 6 dedicated functions keys.
- 4** 4 programmable keys with Led and paper label.
- 5** Navigation.
- 6** Permanent feature keys: quick access to the phone's main features.
- 7** Wired handset.
- 8** 3.5 mm, 4 pole jack (international standard L-R-MIC-GND, European standard L-R-GND-MIC).
- 9** Magnetic alphabetic keyboard.
- 10** An adjustable and stable foot.
- 11** Loudspeaker.

1.4.2 Main screen

Date and time

Display the page by selecting the corresponding tab.

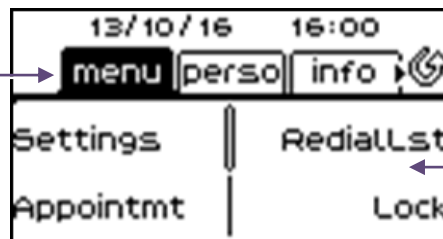

Forward icon.

Softkeys: Menus and actions available depending on the selected page.



Ok key: use to validate your choices and options while programming or configuring.

Left-right navigator: use to move from one page to another and display information about current calls (call in progress, calls on hold, incoming call).

Up-down navigator: use to scroll through the content of a page.



Back/exit key: use this key to go back to the previous step. Use this key to go back to the homepage (long press).



Manage your call forwarding by pressing the key associated with the forward icon.

- stationary white icon: no forwarding activated.
- blinking arrow: forwarding activated.

1.4.3 Call management screen

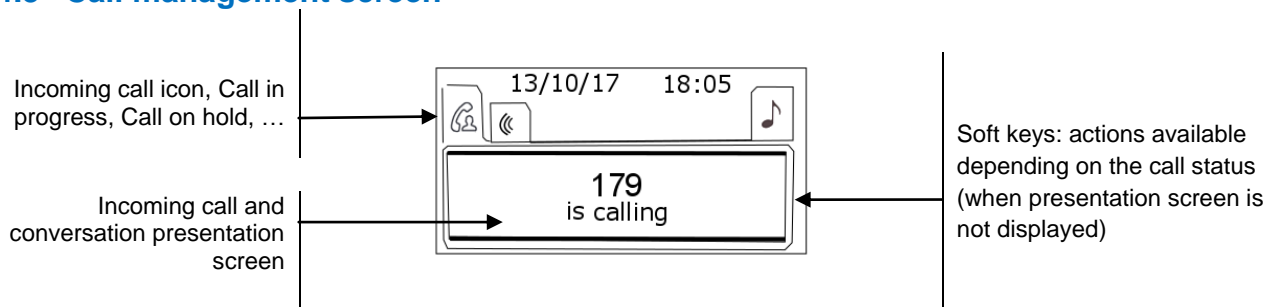

Each tab corresponds to a call, the status of which is symbolized by its icon (in progress, call on hold, arrival of new call). When a call is in progress, use the left-right navigator to look at calls on hold or incoming calls.



All features are accessible while the call is displayed on the screen. Use the Up and Down arrows to move up or down a page. These functions (transfer, conference, etc.) are directly related to the status of the call consulted. For example, the transfer function will not be available between a call in progress or a call on hold and an incoming call.



Used to switch from a telephone screen to an application screen. For example, it can be used while a call is in progress to search a number, program an appointment reminder, etc

Calls can also be managed from the Perso page. While the call is in progress, press the Back/Exit key and display the Perso page. Calls in progress or waiting calls are displayed on the different line keys. It is then possible to converse with the caller of your choice by pressing the key associated to the caller.

1.4.4 Access to the user local menu

(long press) > Open the user local menu: *Audio, Display* (See:User local menu).

1.4.5 Changing or updating the paper label

Removing the paper label

- Lift the protective cover at the notch (1).
- Remove the paper label in the same way (2).
- Update or replace the paper label.

Inserting the phone label

- Position the phone label, left side first, making sure it is placed correctly behind the notches (a,b,c,d).
- Put the protective cover back in the same way.

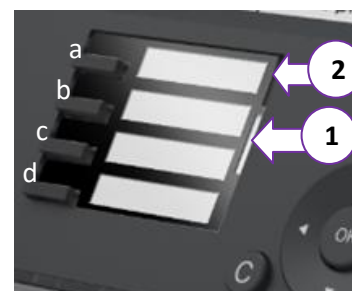



The application 'LabelSet' is available to help you to print the paper labels. Please contact your business partner for more information.

1.5 Welcome screens



1.5.1 Homepage description



You can access all of your phone's features from these screens. The default display has three pages that you can access by pressing to the page tabs at the top of the screen. The selected page is highlighted. The default pages can be augmented with other applications (ACD for example) installed and/or configured on your system.

- Menu page: *Menu*
Contains all features and applications accessible by pressing the label of the desired feature or application. From this page, it is possible to adjust the ringer volume, program the time of an appointment, lock the terminal, define the default page displayed, configure voice mail, and access telephone functions such as calling back one of the last numbers or intercepting calls.
- Perso page: *Perso*
Contains call line keys (allowing supervision of calls) and programmable call keys.
- Info page: *Info*
Contains information on the telephone and the status of its functions: name, telephone number, number of messages (including call log events, instant messages and voice messages), activation of transfer function, appointment reminder, etc.
-  /  Forward icon: Press the icon (touchscreen) or the key next to this icon to program or change the transfer function.
- Press the label (touchscreen) or press the key in front of the label to select the corresponding feature.
- The 8058s Premium DeskPhone provides 4 programmable softkeys. Press the key in front of the softkey to activate it (call a contact, forward to a number, ...).

Choose the page displayed by default on the telephone

- *Settings* › *Options* › *Homepage*
- Select the default page (Menu, Perso, Info, Last page seen ...).
- **OK**

1.6 User local menu

 or  (long press): Open the user local menu.

The user local menu depends on the type of the set.

Audio

Use this menu to adjust the audio convenience according to your environment, the type of device connected and your audio preferences:

- *Jack config.*
Configure the type of the device connected to the audio jack (*Headset, Handset, Handsfree, Loudspeaker*).
- *Devices*
Select the preferred audio device (connected or integrated).
- *Hearing Aid*
Check this option if you are using a hearing aid.

Display

Use this menu to adjust the display of your set:

- *LED brightness auto*
When this option is checked, the phone automatically adjusts the brightness of the display depending on the lighting conditions to improve user experience and achieve power savings (ambient light sensor).
- *Brightness*
Adjust the brightness of the display, the LEDs and the logo on back shell (optional).
- *Advanced > Low brightness*
When the phone is not in use, the brightness is dimmed. Adjust dimmed brightness.
- *Advanced > Busy light*
Activate/deactivate the light of the logo on back shell (optional). The logo on back shell can be illuminated. The color changes when you are busy.
- *Advanced > LED brightness auto*
When this option is checked, the phone automatically adjusts the LED brightness and the busy light logo on the back shell (if present) depending on the lighting conditions to improve user experience and achieve power savings (ambient light sensor).
- *Screensaver*
Set the delay before the brightness is dimmed when the phone is not in use.

Bluetooth

Use this menu to configure the Bluetooth device (optional):

- *Devices*
Display all paired Bluetooth devices, remove a Bluetooth accessory (headset, handset, etc.).
- *Search devices*
Install a Bluetooth® Wireless accessory (headset, handset, etc.).
- *Parameters*
Use your DeskPhone as a Bluetooth audio accessory.







Skin

Change the theme (skin) of your phone (optional).

 The 8078s Premium DeskPhone has a specific menu to manage Bluetooth devices (add device, list of paired devices, remove device).









1.7 Status icons/ Call icons

Icons giving information about some specific configurations of the phone or about call status are displayed in the top bar of the screen.

	Headset connected.
	Telephone locked.
	Appointment programmed.
	Incoming call icon.
	Call in progress icon.
	Call holding icon.
	Phone in Bluetooth detectable mode.

1.8 Permanent features keys

They are located just above the loudspeaker

	<p>Mute and intercom key.</p> <p>During a call, press this key to stop your contact from hearing you. When idle, press this key to switch the phone to intercom mode. When you receive a call, the phone hooks off automatically and you go straight into handsfree mode. When activated, this is key blue.</p>
	Turn down the volume/Lower the contrast.
	Turn up the volume/Increase the contrast.
	Pressing this key answers an incoming call in handsfree mode (the key is blue). When a call is in progress, pressing this key switches from handsfree mode to headset or handset mode.
	Programmable keys (F1 and F2 keys): Lit when the function associated with the key is activated. A service or a direct call can be associated to these keys.
	<p>Redial key: to access the 'Redial' feature.</p> <p>Last number redial (short press).</p> <p>Call back on the last 10 numbers dialed (long press).</p>
	<p>Quick access to user local menu (long press).</p> <p>Used to obtain information on functions of the 'menu' page and to program key of the 'perso' page (short press).</p>
	<p>Messaging key to access the messaging portal (call log, voice messages and instant messages).</p> <p>This key flashes blue when there is a new event such as a new voice message, a new instant message or a new event in the call log.</p>

1.9 Magnetic alphabetic keyboard





Your set is provided with a magnetic alphabetic keyboard. The keyboard depends on your country and languages. The magnetic keyboard is automatically fixed on the base of the set. It is connected to the corresponding connector behind the phone.



- Country variants:
 - AZERTY
 - QWERTZ
 - QWERTY (international)
 - QWERTY (nordic)

Use the keyboard to enter names while configuring the phone. Directly access the dial by name feature by entering the name of your caller on the keyboard.

Below is a list of the function keys that allow you to access all the symbols.

	Cursor moving keys (left, right, up and down). Allows you to navigate edit boxes. Press the Alt key to access the left and up directions.
	Caps lock: to write text in capital letters.
	Alt key: to access specific and punctuation characters.
	Enter key: to validate edited text.
	Backspace key: to delete one character in an edit box.

1.10 Description of the connectors

Various connections to allow phone extensions.



1	Universal Serial Bus (USB-c) connector (not available on the 8028s Premium DeskPhone)
2	Add-on module/external ringer connector (SATA type).
3	Magnetic alphanumeric keyboard connector (RJ 9).
4	Universal Serial Bus (USB-a) connector for an audio equipment, a low smartphone charger or USB stick.
5	10/100/1000 Mbps Ethernet connectors to a PC (RJ45).
6	10/100/1000 Mbps Ethernet connectors to the enterprise network (LAN - RJ45).
7	DC power jack for an external power adaptor.
8	Wired handset connector (RJ9).
9	RJ 11 connector for external ringer and audio active envelop indicator.

1.11 Add-on module

Phone capabilities can be extended with Add-ons:



- Premium Smart Display 14 keys.
- Premium Add-on 40 keys.
- Premium Add-on 10 keys.

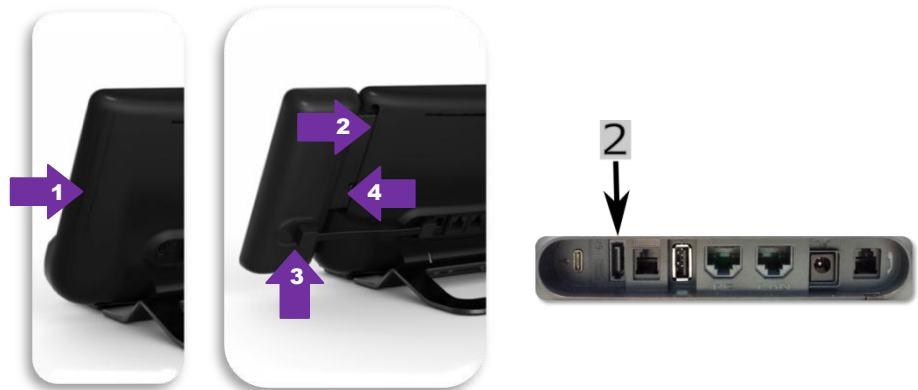

1.11.1 Install the add-on to the deskphone

- **Premium Add-on 10 keys**





- Remove the protection of the dedicated compartment behind the set.
- Insert the add-on correctly in the compartment.
- Plug the provided cord into the dedicated sockets behind your set and the add-on (2: ).
- Fix the add-on with the provided screw.
- Restart the deskphone (unplug and plug in the power jack if you are using an external power adapter or the Ethernet connector – LAN).
- **Premium Add-on 40 keys / Premium Smart Display 14 keys:**
 - Plug the provided cord into the dedicated socket behind your phone and behind the add-on (.
 - If desired, fix the foots (set and add-on) with the provided clip.
 - Restart the deskphone (unplug and plug in the power jack if you are using an external power adapter or the Ethernet connector – LAN).

Manage and use the add-on keys as a direct call key. See chapter: Programming your telephone.

1.11.2 Install more than one add-on module

It is possible to connect up to three add-on modules (Premium Smart Display 14 keys, Premium Add-on 40 keys). To attach another add-on, affix and connect the new add-on to the one that is already connected:

- The first add-on is connected to the deskphone.
- Plug the provided cord of the new add-on into the dedicated socket behind the connected add-on (.
- Plug the other end of the cord into the dedicated socket behind the new add-on (.
- Restart the deskphone (unplug and plug in the power jack if you are using an external power adapter or the Ethernet connector – LAN).

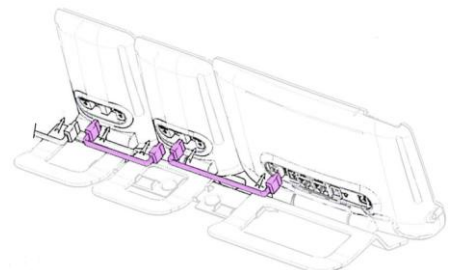

1.11.3 Attach the add-on with the clip

You can attach the base (set and add-ons) with the add-on clip, which is available as an option in pack.

Premium Smart Add-on

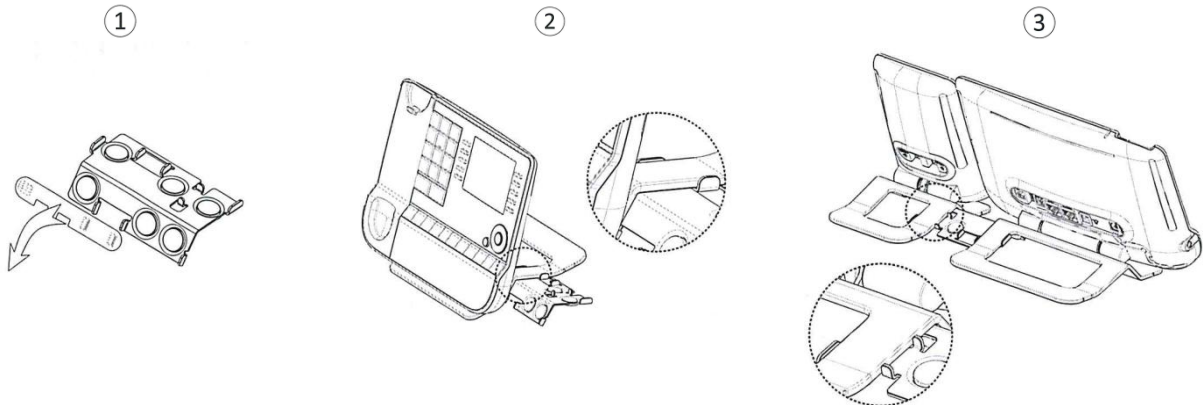

1 Remove the protection on the add-on clip

2 Place the clip in the correct position under the base of the phone, as shown in the image

3 Place the add-on onto the clip, as shown in the image

Premium Add-on 40

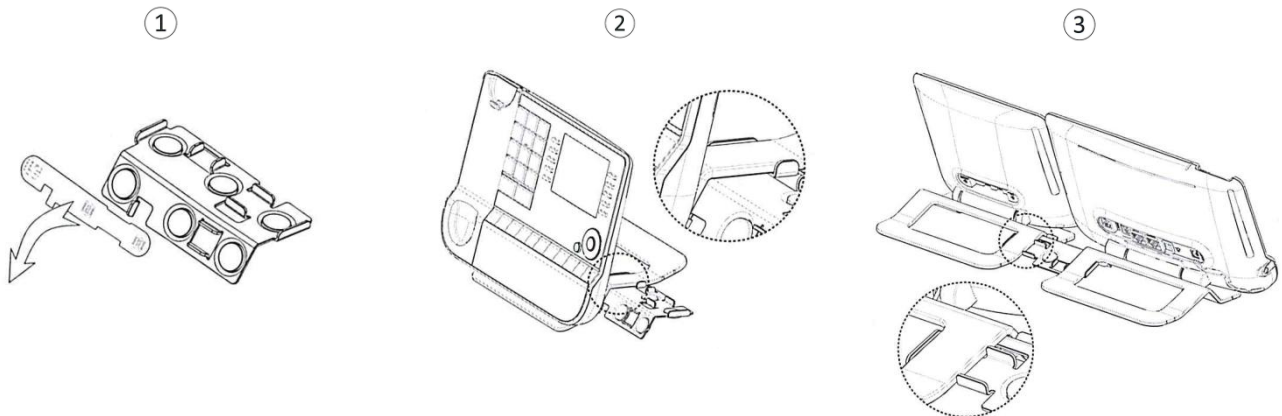

1 Remove the protection on the add-on clip

2 Place the clip in the correct position under the base of the phone, as shown in the image

3 Place the add-on onto the clip, as shown in the image

Use the same procedure to attach an add-on to another add-on.

You can attach one or more add-ons to your phone. To attach another add-on, affix and connect the new add-on to the one that is already connected.

1.11.4 Changing or updating the paper label

- **Premium Add-on 10 keys (with paper labels)**

- Remove the protective cover (1): Insert a thin object (or your fingernail) in the slot (a) to lift the protective cover. Carefully remove the cover at the first notch (b). The cover is held in place by small notches, take care not to break the plastic cover near the notches. Remove the cover from the other notches (c, d) by moving the cover gently from right to left (←→).
- Remove the paper label with a thin object.
- Replace the paper label and protective cover (2): The cover or the paper can only be placed in the right way. It has to cover all the paper area. If not, return it. Position the paper label, right side first, by inserting it under the plastic notches (a). Then, insert the other notches (b) by gently pressing the paper near each notch. Put the protective cover back in the same way.

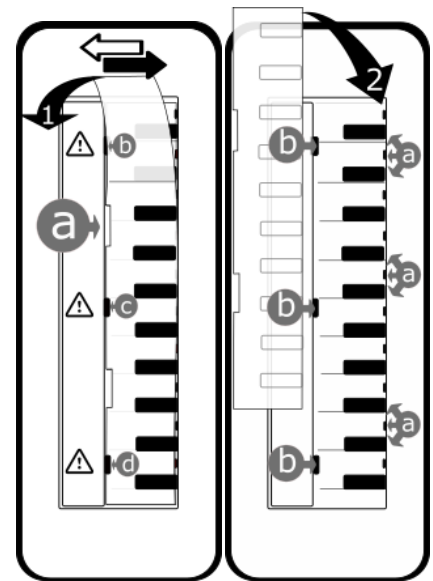

- **Premium Add-on 40 keys (with paper labels)**

- Remove the protective cover (1): Insert a thin object (or your fingernail) in the correct position (a) to lift the protective cover. Carefully remove the protective cover. The cover is held in place by small notches, take care not to break the plastic cover near the notches.
- Remove the paper label in the same way
- Replace the paper label and protective cover (2): The cover or the paper can only be placed in the right way. It has to cover all the paper area. If not, return it. Position the paper label, right side first, by inserting it under the plastic notches (c). Then, insert the other notches (b) by gently pressing the paper near each notch. Put the protective cover back in the same way.
- Follow the same method for each paper area.

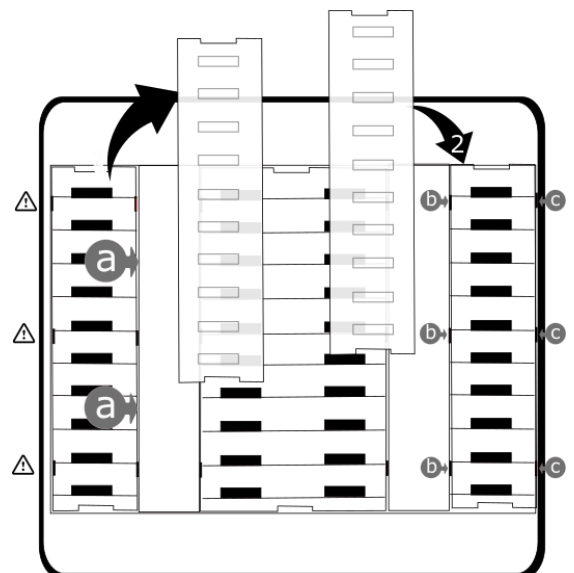

The application 'LabelSet' is available to help you to print the paper labels. Please contact your business partner for more information.

1.12 Bluetooth® Wireless handset

The Bluetooth® Wireless handset is only available with compatible Bluetooth® deskphones.

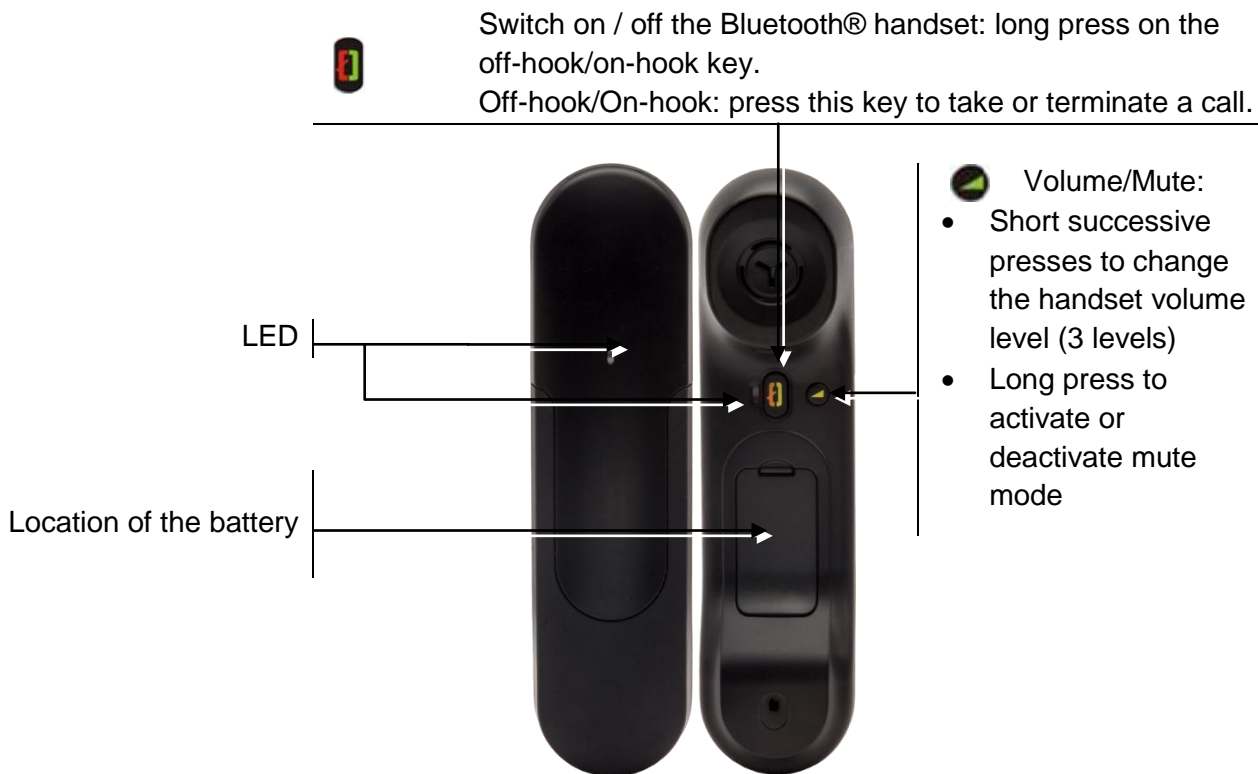

1.12.1 LED

- Off: operating normally.
- Green flashing: in communication.
- Green steady: handset charging.
- Orange flashing: battery charge low or handset outside coverage zone.
- Orange steady: malfunction.

If the Bluetooth® handset is on its base, you do not need to press the Off-hook/On-hook key to take or terminate the call. Just off-hook/on-hook the Bluetooth® handset.

1.12.2 Installing or replacing the Bluetooth® handset battery

At the first use, you have to connect the battery to the handset. The battery is placed in its compartment but it is not connected. To install a new battery, follow instruction:

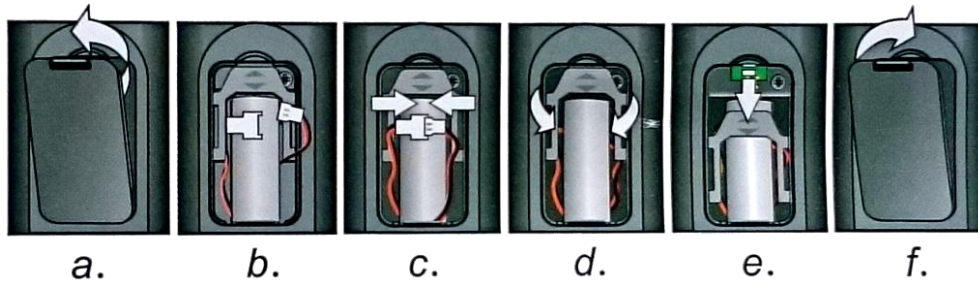

- a) Lift up the battery cover.
- b) Take the 2 connectors.
- c) Assemble the 2 connectors.
- d) Arrange the battery, the cable and the connectors in the battery compartment (place the connected side of the battery in the bottom of the compartment)
- e) Slide out the battery holding part.
- f) Replace the cover.

The battery recharges when the Bluetooth® handset is on its base.



Switch on / off the Bluetooth® handset: long press on the off-hook/on-hook key.

Defective batteries must be returned to a collection point for chemical waste disposal.

1.13 Installing a Bluetooth® Wireless Technology handset (pairing)

This feature is only available with compatible Bluetooth® deskphone. Otherwise the corresponding menu is not displayed or is inactive.

Before a Bluetooth® headset can be used, it must be correctly paired to the terminal.

- Use one of the following:
 - 
 -  (long press) › *Bluetooth*
- *Search devices*
-  With the handset turned off, press the 2 Bluetooth® handset keys at the same time (long press).

» You will hear a 3 note signal and the LED will flash green and orange alternately.

» Searching for Bluetooth® equipment. Wait for the detected equipment type and address to be displayed.

- Select the relevant equipment: ALE BT Handset.
- *Add*
- Enter the PIN code of the device if necessary.
- *Confirm* » The 3-note tone indicates that the handset has been installed correctly. The LED flashes green or orange depending on the battery charge level.

1.14 Install a comfort wired handset

You can install a wired handset in place of the Bluetooth® Wireless Handset.

- Remove the rubber.
- Plug-in the wired handset to the appropriate connector (refer to phone description).
- Make sure you position the cable correctly in the compartment intended for that purpose.
- Switch off the Bluetooth® Wireless Handset (press and hold the On/Off hook key until you hear distinct tones).



2 Using your telephone

2.1 Messaging portal

The messaging portal allows you to access and manage features such as the call log, instant messaging and voice messages. When there is a new event (new log, new instant message or new voice message) the message key blinks blue.



Accessing the messaging portal

-  Press the message key to access the messaging portal.

Configure access to the messaging portal

The system default setting requires you to enter your personal password to access the messaging portal features. The password information is retained for a few seconds so that if you quit the messaging portal you can access it again after a few seconds without having to re-enter your password. The length of this time-out depends on your system configuration. For more information, contact your installer or administrator.

You can change the setting so that you don't have to enter a password each time you want to access the messaging portal features.





-  Access the messaging portal.
- *Configure*
- *Authentication*
- Enter your personal password.
- Set authentication to on or off.
 - On: password is always required.
 - Off: password is never required.
-  Press to confirm.

Accessing the features of the messaging portal

To access the available features (call log, instant messages IM, voice messages, sending an instant message), press the associated softkey.





Acknowledging

When you consult a new event (call log, instant message or voice message), the event is automatically acknowledged. However, you can choose to acknowledge all events without consulting them.

-  Access the messaging portal.
-  Press the associated softkey.
-  Press the softkey associated with the type of event you want to acknowledge. If you press the key associated with the 'all' option, all new events are acknowledged. You can also acknowledge all events if you press the softkey associated with the check icon in the top right corner of the screen.
-  Press to confirm.

Deleting

When consulting an event (call log, instant message or voice message), you can delete the event once you have consulted it. However, you can choose to delete all events in one go.

-  Access the messaging portal.
-  Press the associated softkey.
-  Press the softkey associated with the type of event you want to delete.
-  Press to confirm.

2.2 Consulting the call log

At any time, you can consult all answered and unanswered incoming and outgoing calls. To do this, go to the call log feature on the messaging portal.

-  Access the messaging portal.
- Press the softkey associated with the call log feature.

You can choose between consulting missed calls only ('Missed' tab) and consulting all call logs including unanswered/answered, incoming and/or outgoing calls ('All' tab).

Consulting missed calls



- Select the 'Missed' tab.
Unacknowledged calls are in bold characters.
- Select the log to consult.
-  Display the log details.

Information such as the name, phone number, date and time are displayed on the screen.

You can choose to call the contact, send an instant message to the contact, save the contact in the personal phonebook, or clear the log.



Acknowledge all missed calls:

Once a new log is consulted, it is automatically acknowledged. However, you can acknowledge all new missed calls without consulting them.

-  Press the associated softkey.
-  Press the associated softkey.

All missed calls are acknowledged.

Delete all missed calls:

-  Press the associated softkey.
-  Press the associated softkey.
-  Press to confirm.

All missed calls are deleted.

Consulting all calls

- Select the 'All' tab.

All calls are displayed with an icon giving information on the type of call.

Color screen:

	Answered outgoing calls		Answered incoming calls
	Unanswered outgoing calls		Unanswered incoming calls

Monochrome screen:



	Answered outgoing calls		Answered incoming calls
	Unanswered outgoing calls		Unanswered incoming calls

- Using the up and down navigation key, select the log to consult.
-  Display the log details.



Information such as the name, phone number, date and time are displayed on the screen.

You can choose to call the contact, send an instant message to the contact, save the contact in the personal phonebook, or clear the log.

Acknowledge all missed calls:





-  Press the associated softkey.
-  Press the associated softkey.
All missed calls are acknowledged.

Delete all call logs:

-  Press the associated softkey.
-  Press the associated softkey.
- Press to confirm.
All call logs are deleted.

2.3 Making a call

Use one of the following:

- Dial directly the number for your call.
- Lift the receiver › Enter the destination number.
-  Press the on-hook/off-hook key of the Bluetooth® device (Bluetooth® Wireless handset) › Dial the destination number.
-  Hands free › Dial the destination number.
- Programmed line key.
- Dial by name (enter the first letters of the contact's name on the alphapad and press OK to start the search).
-  From call log after accessing the messaging portal.
-  Redial last number.

To make an external call, dial the outside line access code before dialing your contact number.

The duration of your external call may be limited in time by the administrator. In this case, a beep sounds and/or a message will be displayed on the screen 20 seconds before the end of the communication.





2.3.1 If the internal or outside number does not reply

Use one of the following:

- *Interphony*: Broadcast a message on the loudspeaker of the free terminal.
- *Callback*: Request callback to a busy terminal.
- *Text*: Send a written message.



2.4 Receiving a call

When receiving a call, you can:

- Lift the receiver to take the call.
-  /  /  Press the 'take the call', 'loudspeaker' or 'line key' key to take the call in handsfree mode.
-  Press the On-Hook/Off-Hook key on the Bluetooth handset to take the call (if handset is not on-hooked) - Bluetooth® Wireless handset.
-  Select the incoming call icon. With the touchscreen, selecting the icon displays information about the incoming call, you can touch near the icon (external free area) to answer the displayed call directly.
- *Answer*

2.5 Using the telephone in 'Hands free' mode

2.5.1 Terminal idle







-  Press and release **>>** You are in hands free mode.
-  Terminate your call.

2.5.2 Call in progress

- During a conversation
-  Press and release **>>**  You are in hands free mode.

During a conversation, you can lift the receiver without terminating the call.

2.6 Activating the loudspeaker during a conversation (handset lifted)

- During a conversation.
-  Activate loudspeaker **>>**  **>>** The key lights up.
-   Adjust volume by pressing the volume keys (number of levels: 7).
-  Deactivate loudspeaker **>>**  **>>** The key is no longer lit.

Press and release the loudspeaker key to switch to hands free mode (light steady).

2.7 Calling a contact using the search by name feature



You can call a contact using the search by name feature. This feature enables you to call a contact directly on their company phone or call them on another phone using their contact card.

The search by name feature provides two modes:

- *Internal*: Classic search of the corporate directory.
- *Unified*: Predictive search of the corporate directory.





Please be aware that predictive searching means that you won't have access to the contact card, and therefore can only call the contact on their company phone.

Switching between the two modes:

- Press a letter to launch the dial by name function.
-   *Options*
- The current mode is displayed.
- Select the new mode:
 - *Internal*: The internal directory mode is enabled.
 - *Unified*: The unified directory mode is enabled.
 - *OK*: Stay in the current mode.

2.7.1 Calling a contact using the unified directory

- Enter the first letter of your contact's surname.
When entering the name you can extend the search by adding the first letters of the first name after entering the '#' symbol or pressing: *1stname*
-  Start the search.
- A list of matching names is displayed on the screen. Each contact is displayed with their name and company phone number.

- Use one of the following:
 -   Scroll and select your contact in the list of matching names.
 -   Modify the search.

Call your contact using the company phone number

- Press the softkey associated with the company phone number.

Call your contact using another phone number (via contact card):





- Press the softkey associated with the contact name:
The contact card opens and displays information about the contact: last name and first name, several phone numbers (Office, mobile, home), email address, instant message address and the company name.
- Scroll through the screen with the up and down navigation keys and position the cursor on the contact phone number you wish to call.
-  Start the call.

From the contact card you can also send an instant message.

-  Use the Guide key to display information that is truncated.

You can change the search by name function to predictive search mode by setting the unified directory to 'Off' in the settings menu (available once a search by name is started). Please be aware that predictive searching means that you won't access the contact card and therefore can only call the contact on their company phone and cannot send instant messages.

2.7.2 Calling a contact using the internal directory (predictive search)

- Enter the first letter of your contact's surname. You enter your contact's name in predictive text mode. In this mode, enter each letter of the name by pressing only once on the key with this letter.
- The search runs as soon as you enter a character (predictive search). The matching names are displayed.
- Use one of the following:
 -   Display the previous and next names.
 -  Press the OK key to start the call with the displayed contact (company phone number).
 -   Modify the search.

You can switch to the other search mode by enabling it in the options menu (available once a search by name is started).

This feature depends on the system configuration. If necessary, contact your administrator...

2.8 Make calls via your programmed call keys (Perso page/F1 and F2 keys/Add-on module)

If you have programmed a direct call key, select it to make the call.

2.9 Filtering calls using the voice mailbox



This service lets you filter incoming calls to your voice mailbox. When your caller leaves his message you can choose to communicate with him. This feature depends on the system configuration. If necessary, contact your administrator.

2.9.1 Activating call screening

- Voice mail filtering programmed key.
- Enter your personal password.
- Same key to stop listening and deactivate the screening.

2.9.2 When you receive a call

You hear the message left by your caller.
Use one of the following:



-  Hands free to take the call.
- Lift the receiver.
-  To stop listening only.

2.10 Redialing

2.10.1 Redialing the last number dialed (redial)

-  (short press) >> Last number redial.

2.10.2 Call back on the last 10 numbers dialed

-  (long press).
- Select the number to redial from the last 10 dialed numbers.
-  or **OK** Start the call.

You can also access this feature through the menu:

- Reach the 'Menu' page.
- *Redial list*
- Select the number to redial from the last 10 dialed numbers.

2.11 Requesting automatic callback if internal number is busy

- Internal number busy.
- *Call back* >> Callback request acknowledged.
- 

Automatic callback is not available if the set of your caller is free or if you are put on hold when the set is busy.

2.12 Cancelling an automatic callback

- When your phone rings.
- *Call back* >> *Cancellation of callback request acknowledged.*

Canceling the callback request is only possible when the caller you tried to reach released the line.

2.13 Receiving intercom calls

You can answer a call without lifting the receiver. When you receive a call, you are automatically connected in hands-free mode. The identity of the caller is displayed on the screen.

To activate Terminal idle:

-  >> Corresponding LED lights up.

When your caller hangs up, interphony mode remains active.

To deactivate Terminal idle:

-  >> The corresponding LED goes out.

2.14 Sending DTMF signals

During a conversation you sometimes have to send DTMF signals, such as with a voice server, an automated attendant or a remotely consulted answering machine.

- During a conversation.
- *Send DTMF*
- Enter DTMF code.



The function is automatically cancelled when you hang up.

2.15 Mute, so that your caller cannot hear you



You can hear your caller but he/she cannot hear you:

You can hear your caller but he/she cannot hear you:

2.15.1 From the set

- During a conversation.
-  Disable microphone >> The mute key blinks.
-  Resume the conversation >> The mute key no longer blinks.





2.15.2 From the Bluetooth® receiver (Bluetooth® wireless handset)

-  Press the handset volume/mute key (long press) >> The mute key blinks.
-  Press the handset volume/mute key (long press) >> The mute key no longer blinks.



2.16 Sending an instant message to a contact

You can send an instant message to a contact by entering either their phone number or their name.

2.16.1 Sending an instant message using the search by name feature



-  Access the messaging portal.
- *Send IM*
- Enter your password if required.
- Enter the first letters of the name.
When entering the name you can extend the search by adding the first letters of the first name after entering the '#' symbol or pressing: *1stname*.
-  Start the search.
- A list of matching names is displayed on the screen. Each contact is displayed with their name and company phone number.
- Press the softkey associated with the contact name:
The contact card opens and displays information about the contact: last name and first name, several phone numbers (Office, mobile, home), email address, instant message address and the company name.
- Scroll through the screen with the up and down navigation keys and position the cursor on the instant message address.
-  Access instant message writing mode.
- Write the instant message to send.
-  Send the instant message.

2.16.2 Sending an instant message using the phone number

-  Access the messaging portal.
- *Send IM*
- Enter your password if required.
- Enter your contact's phone number.
-  Access instant message writing mode.
- Write the instant message to send.
-  Send the instant message.

2.16.3 Status of the instant messages





Once the instant message has been sent, the message is stored in the 'Sent' tab of the instant message feature in the messaging portal. The status of the message is as follows:

	Instant message has been sent but not yet delivered.
	Instant message has been delivered.
	Instant message has been read.



2.17 Answering with an instant message

You can send instant messages to your contacts when you have received an instant message or a voicemail or you can send instant messages when consulting the call log.



2.17.1 Answering an Instant message

-  Access the messaging portal.
- Select the instant message feature by pressing the associated softkey.
- Enter your password if required.
- Using the left and right navigation keys, access one of the following tabs: new messages, received messages, sent messages or all messages.
- Using the up and down navigation keys, position the cursor on the instant message you want to answer.
-  Select the instant message.
-  Answer the instant message by pressing the associated softkey.
- Write the instant message to send.
-  Send the instant message.

2.17.2 Answering a voice message





-  Access the messaging portal.
- Select the voicemail feature by pressing the associated softkey.
- Enter your password if required.
- Using the left and right navigation keys, access one of the following tabs: new voice messages or all voice messages.
- Using the up and down navigation keys, position the cursor on the voice message you want to answer with an instant message.
- When details of the voice message are displayed on the screen, press the softkey associated with the instant message.
- Write the instant message to send.
-  Send the instant message.

2.17.3 Answering from the call log

-  Access the messaging portal.
- Press the softkey associated with the call log feature.
- Enter your password if required.
- Using the left and right navigation keys, access one of the following tabs: missed calls or all calls.
- Using the up and down navigation keys, position the cursor on the call log you want to consult.
-  Select the call log.
- When details of the call log are displayed on the screen, press the softkey associated with the instant message feature.
- Write the instant message to send.
-  Send the instant message.

2.18 Consulting instant messages

You are notified of a new event when the message key is flashing.



-  Access the messaging portal.
- Select the instant message feature by pressing the associated softkey.
- Enter your password if required.
- Using the left and right navigation keys, access one of the following tabs: new messages, received messages, sent messages or all messages.
- Using the up and down navigation keys, position the cursor on the instant message you want to read.
-  Select the instant message.
- Once the instant message is read, you can:
 -  ← Answer the instant message by pressing the associated softkey.
 -  Delete the instant message by pressing the associated key.
 -  Press OK to call the sender of the instant message.

When a message is read, the status of the message changes from unread to read on both sides (on the recipient side and the sender side).

You can use the filter key to consult messages sent by or to a particular contact. For example, when you are on a message sent by a contact, pressing the filter key shows only messages sent to or by that contact.



Acknowledge new instant messages

Once a new instant message is read, it is automatically acknowledged. However, you can acknowledge all new instant messages without reading them.

-  Press the associated softkey.
 -  Press the associated softkey.
- All new instant messages are acknowledged

Delete instant messages

When consulting the instant messages, you can choose to delete the messages stored in the following tabs: new, sent, received or all messages.





-  Press the associated softkey.
-  Press the associated softkey.
-  Confirm deletion.

3 During a conversation

3.1 Making a second call during a conversation

During a conversation.

Use one of the following:

- Dial directly the number for your call.
- Name of second caller.
- *New call* > Number of second caller.
- *New call* > *Redial list* > Select the No. in the last ten issued.
- *New call* > *Speed dial* > Select the programmed key.
-  (long press) or   / Menu page: / *Redial list* / Select the No. in the last ten issued.
-   / Perso page/ Programmed line key.
- The first call is on hold.





3.1.1 Cancel your second call

Use one of the following:

- On hook the handset.
-  Hang up key (If in handsfree mode).

3.1.2 Recover the call on hold



Use one of the following:

-   Select the incoming call icon. With the touchscreen, selecting the icon displays information about the incoming call, you can touch near the icon (external free area) to answer the displayed call directly.
-  Hands free to take the call.
- Lift the receiver.
-  Start call key.

You are in conversation with your first caller again.

If you make an error, hang up: your telephone will ring and you will recover your first call.

3.2 Answering a second call during a conversation

- During a conversation, another person is trying to call you. The name or number of the caller is displayed for a few seconds.
- Use one of the following methods to answer the displayed call.
 -   Line key for which icon is flashing. With the touchscreen, selecting the icon displays information about the incoming call, you can touch near the icon (external free area) to answer the displayed call directly.
 - *Queue* or *Waitqueue* › *Answer*
- The first call is on hold.





3.2.1 Cancel your second call

Use one of the following:

- On hook the handset.
-  Hang up key (If in handsfree mode).

3.2.2 Recover the call on hold

Use one of the following:

-   Select the incoming call icon. With the touchscreen, selecting the icon displays information about the incoming call, you can touch near the icon (external free area) to answer the displayed call directly.
-  Hands free to take the call.
- Lift the receiver.
-  Start call key.



You are in conversation with your first caller again.

If you make an error, hang up: your telephone will ring and you will recover your first call.

3.3 Switching between calls (Broker call)

During a conversation, a second call is on hold.

Use one of the following:

-   Select the call on hold icon from the conversation screen. With the touchscreen, selecting the icon displays information about the incoming call, you can touch near the icon (external free area) to answer the displayed call directly.
- *Answer*
- Press the Back/Exit key to display the Perso page. Select the call on hold.

›› Your first call is placed on hold.

3.4 Transferring a call

During a conversation, to transfer the call to another number:

You are in communication with a first caller

- Calling a second person during a conversation ›› The first call is on hold.
- You can transfer the call immediately or wait for your contact to answer before transferring the call.
- *Transfer*
- The two callers are connected.

You are in communication with a first caller. A second caller is on hold.

- You want to connect the first caller with the second.
- *Transfer*
- The two callers are connected.

Transfer between two outside calls is not generally possible (depends on country concerned and system configuration).

3.5 Transfer a call to a voice mail

During the call, you want to transfer your caller to the voice mailbox of another caller

- *TransferVMU*
- Number of second caller.

3.6 Three-way conference with internal and/or external callers (conference)

- During a conversation, a second call is on hold.
- *Conference* » You are in conference mode.

3.6.1 Cancel the conference and recover the last active call before the conference (the other is on hold) (If conference is active)

- *xConference*

3.6.2 Hang up on all caller (If conference is active)

Use one of the following:



-  Hang up.
- On hook the handset.

3.6.3 After the conference, to leave your two callers talking together

- *xConference*
- *Transfer*



3.7 Placing a call on hold (hold)

During a conversation, you wish to place the call on hold and recover it later, on the same telephone.

- During a conversation.
- *Hold* » Your call is placed on hold  .

Recover the call on hold

Use one of the following:

- Hang up, your phone is ringing, then answer the call.
-   Select the call on hold icon from the conversation screen. With the touchscreen, selecting the icon displays information about the incoming call, you can touch near the icon (external free area) to answer the displayed call directly.
- *Answer*
- Press the Back/Exit key to display the Perso page. Select the call on hold.

3.8 Placing an outside call on hold (parking)

You can place an outside call on hold and recover the call on another telephone:

- During a conversation.
- *Park call*

3.8.1 To recover the parked call

- Reach the 'Menu' page.
- *Pickup* > *Unparkcall*

If the parked call is not recovered within a preset time (default value 1 min 30), it is transferred to the operator.

3.9 Intrusion into an internal conversation

Your caller's line is busy. If the number is not 'protected' and if authorised, you can intrude into the call:

- **Intrusion*
- Same key to exit (**Intrusion*).

3.9.1 Protection against intrusion

- Press programmed key.
- Enter caller's number.

Protection is cancelled when you hang up.

3.10 Store a number

During a call, to save the number onto a call key:

During a conversation.

- *Savetorep*
- Press a call key on the Perso page.
- Enter the name of your caller.
- Apply.

3.11 Adjust audio volume

During a call, to adjust the volume level of the loudspeaker or receiver:

- During a conversation.
-   Adjust audio volume.

4 'Meet me' conference

The 'Meet me' function is used to set up a conference with a maximum of 6 persons: the 'master' of the conference (who has the rights for initiating the conference) and the participants (maximum of 5) who meet for the conference.

4.1 Initiate a 'Meet me' conference

In order for the participants to join the conference, you must first decide on a meeting time for the conference and send them the access code.

- Lift the receiver.
- Enter the 'Meet me' conference activation code. This code is defined by the administrator during system configuration. If necessary you may need to contact your administrator.
- Enter your telephone number (internal).
- Enter your personal password.
- Enter the conference access code.

The conference is set-up. Participants must enter this access code to join the conference call. Send the conference call access code to the participants.

When the system prompts you to enter a code or password, you are allowed 3 attempts before the system rejects your request.

Call number for activating the 'Meet me' conference: this call number is used by the conference master when he wishes to initiate a conference from an external set. This number must have been defined previously by the system administrator.

4.2 Join a 'Meet me' conference

Once set-up by the conference master, the participants can join the 'Meet me' conference (5 participants maximum).

- Lift the receiver.
- Enter the joining code for the 'Meet me' conference. This code is defined by the administrator during system configuration. If necessary you may need to contact your administrator.
- Enter the conference access code.
Conference access code: 4 digit code defined by the conference master and communicated to the participants so that they can join the conference.

You are in conference mode.

When the conference master on-hooks, all the communications will be cut-off.

Call number for joining the 'Meet me' conference: this call number allows the participants to join a conference from an external set.

An audible beep sounds when a participant joins the conference. 2 audible beeps sound when a participant leaves the conference.

You cannot join a conference if there are already the maximum number of participants.

If the conference has not yet been set up by the conference master you are put on hold until the conference is initiated (5 minutes maximum).

If you cannot directly reach the conference, you have to call first an internal user or an automatic operator. This one dials the call number for joining the 'Meet-me' conference and then transfers your call (10 seconds).

5 Sharing

5.1 Receiving supervised call ringing

To receive the special ringing for calls to another number:

- Supervised call ringing programmed key.
- Same key to cancel.

5.2 Answering the general bell

When the operator is absent, outside calls to the operator are indicated by a general bell. To answer:

- Reach the 'Menu' page.
- *Pickup* › *Generalbell*

5.3 Manager/Assistant filtering

System configuration allows 'Manager/Assistant' groups to be formed, so that the manager's calls can be directed to one or more assistants.

5.3.1 From the manager or assistant telephone

- Filter programmed key ›› Incoming calls are filtered by a chosen person (assistant, etc.).
- Same key to cancel.

Filtering is indicated on the manager's telephone by the icon corresponding to the 'screening' programmed key.

5.4 Call pick-up

You hear a telephone ringing in an office where no-one can answer. If authorised, you can answer the call on your own telephone.

5.4.1 If the telephone ringing is in your own pick-up group

- Group call pick-up programmed key.

5.4.2 If the telephone ringing is not in your pick-up group

- Reach the 'Menu' page.
- *Pickup* › *Set*
- Enter the number of the ringing telephone.

The system can be configured to prevent call pick-up on certain telephones.

5.5 Outside calls to the operator will ring on your telephone and you can answer the call

- Operator help programmed key.
- Your telephone will ring at the same time as the switchboard.
- Same key to cancel.

5.5.1 Calls to the switchboard

Calls to the switchboard will ring on your telephone.

- Lift the receiver.
- /
- Operator help programmed key.

5.6 Hunting groups

5.6.1 Hunting group call

Certain numbers can form a hunting group and can be called by dialling the group number.

- Lift the receiver.
- No. of group to be called.

5.6.2 Temporary exit from your hunting group/Return into your group

- Leave group programmed key.
- Enter your group number.

Belonging to a group does not affect the management of direct calls. A specific telephone within a group can always be called by using its own number.

5.7 Calling an internal caller on his/her pager

The number called does not answer and you know that the person called has a pager:

- Paging programmed key.
- Paging in progress is displayed.

Your caller can answer from any telephone in the system.

5.8 Answering a call on your pager

A call on your pager can be answered from any telephone within the system.

Your pager beeps.

- Answer paging programmed key.
- Enter your group number.



5.9 Calling a caller on his/her loudspeaker

Your internal caller does not answer. If authorised, you can remotely activate your caller's phone:

- Your caller does not reply.
- *Interphony*

You are connected to the loudspeaker on your caller's phone (if he/she has the hands free function).





5.10 Send a voice message copy

-  Access the messaging portal.
- Press the softkey associated with the voice message feature.
- Using the left and right navigation keys, select the tab to consult (new or all messages).
- Using the up and down navigation keys, position the cursor on the voice message you want to send.
-  Select the message to send.
- *Sendcopy*
- Enter the destination number.
- 
- *Sendmessage*

When sending a copy of the message, you can also record a comment to join to the copy.

- *Record*
- Start recording the comment.
- *Stop*
- 

5.11 Sending a recorded message to a number or a distribution list

-  Access the messaging portal.
 - Press the softkey associated with the voice message feature.
 -  Press the associated softkey.
 - Enter the number of the recipient or select a destination list.
- or.
- Enter the name of the recipient using the alphapad.
 - 
 - *Record*
 - Start recording the comment.
 - *Stop*
 -  Send the message.

5.12 Broadcasting a message on the loudspeakers of a station group

A message not requiring an answer can be broadcasted on the loudspeakers within your broadcast group:

- Off hook.
- Number of broadcast group >> Speak, you have 20 seconds.
-  or Hang up.

The message will only be broadcast on terminals not in use and which have a loudspeaker.

6 Keep in touch



6.1 Selecting calls to be forwarded

When a forward is applied, you can select the types of call to be forwarded: outside, internal, all.

- 
- *Ext/Int* >> Select the type of Out/Int call >> type of call forwarded is displayed.
- *Allcalls* >> forward internal and outside calls.
- *External* >> Forward outside calls.
- *Internal* >> Forward internal calls.

6.2 Forwarding calls to another number (immediate forward)



The number can be your home, mobile, voice mailbox or an internal extension (operator, etc.).

- 
- *Immediate*
- Number to be called >> Forward is acknowledged.
- 

You can also select the destination number of the forward through the redial feature or the individual repertory.



You can make calls, but only the destination number can call you.

6.3 Forwarding your calls to your voice message service

- 
- *Immediate'VM* >> Forward is acknowledged.
- 

6.4 When you return, consult recorded messages

You are notified of a new event when the message key is flashing.



-  Access the messaging portal.
- Press the softkey associated with the voice message feature.
- Using the left and right navigation keys select the new voice messages tab.
- Using the up and down navigation keys position the cursor on the message you want to listen to.
-  Select the message to listen to.

Display name of sender, with date, time and ranking of message.

- *Play* >> Listen to message.
- *Clear* >> Erase message.
- *Call* >> Call back sender of message.
- *Sendcopy* >> Copy message.
- *Send IM* >> Send an instant message.

Acknowledge all new voice messages

Once you start listening to a voice message, the message is automatically acknowledged. However, you can acknowledge voice messages without listening to them.

-  Press the associated softkey.
-  Press the associated softkey.
- 

6.5 Activate/disable the personal assistant

- Reach the 'Menu' page.
- *Settings* > *Assistant*
- *On* or *Off* >> Activate or deactivate the assistant.
- 

6.6 Personal assistant: reaching you with one number only

- Reach the 'Menu' page.
- *Settings* > *Assistant* > *Menu*
- You can then choose where to route the calls:
 - *InternalNr* >> Dial number of a colleague or your assistant.
 - *ExternalNr* >> Dial an outside line number.
 - *MobileNr* >> Dial number of your mobile or DECT.
 - *Operator* >> Activatedeactivate transfer to operator.
- 

6.7 Forwarding calls to your pager

Callers will thus be able to contact you while you are moving around the company:

- 
- *Topaging* >> Forward is acknowledged.

6.8 Forwarding your calls from the receiving terminal ('Follow me')

You wish to receive your calls in your present location:

Use the 'Follow me' function.

- 
- *Followme*
- Dial your extension number >> Forward is acknowledged.

If you have a key programmed with this feature, you can access the feature directly.

- Press programmed key.
- Dial your extension number >> Forward is acknowledged.

6.9 Diverting all group calls

You can forward all your group calls to another internal number:

- Group calls forwarding programmed key.
- Enter the destination number.
- Forward is acknowledged.

6.10 Cancelling all forwards

- 
- *Cancellwd.*

To cancel all forwards, you can programme another type of forward too.

6.11 Cancelling a specific forward

- Programmed key corresponding to type of forward (group or selective).

6.12 Forwarding calls when your line is busy (forward if busy)

Callers can be forwarded to another telephone if you are already on the line.

- 
- *Onbusy*
- Enter the destination number >> Forward is acknowledged.

6.13 Do not disturb



You can make your terminal temporarily unavailable for all calls.

-  / 
- *DoNotDisturb* >> Forward is acknowledged.

Callers wishing to contact you will see the 'Do Not Disturb' message displayed on their sets when they try to call.

6.14 Leaving a recorded message for internal callers

You can leave a message on your terminal which will be displayed on the screen of the terminal calling you.

-  / 
- *Textanswer*.
- Choose the type of message.

Sending predefined message

- *FixedMsg*.
- Select the message to be sent.
- **OK**

Enter the number of the ringing telephone *Language*.

Notice that you can select the message to send by its number by selecting the option: *Gotomessage*.

The 27 standard messages are shown below:



1	Call me back	15	Meeting on ____ (*)
2	Call me back tomorrow	16	Meeting on ____ at _:_ (*)
3	Call me back at _:_ (*)	17	Out for a while
4	Call back ____ (*)	18	Absent for the rest of the day
5	Call the attendant	19	Absent, back at _:_ (*)
6	Call the assistant	20	Absent, back on ____ at _:_ (*)
7	I will call back at _:_ (*)	21	On vacation, back on ____ (*)
8	Use paging	22	External meeting
9	Please fetch your fax	23	External meeting, back on ____ (*)
10	Please fetch your mail	24	I am in room nr ____ (*)
11	Please cancel your forwarding	25	In a meeting - do not disturb
12	Visitors are waiting	26	At lunch
13	You are expected at reception	27	Indisposed
14	Meeting at _:_ (*)	(*)	Messages to be completed using numeric keypad

Sending a new message

- *NewMsg*.
- Write your message.
- **OK**

6.15 Consulting written messages

The light indicates that messages have been received.

-  » Number of messages received.
- *ReadTxtMsg* » Displays the sender's message on the screen.
- *Readmore* » Displays the rest of the message and the date and time it was left.
- Use one of the following:
 - Use the left-right navigator to see previous and next messages.
 - *Clear* » Erase message.
 - *Call* » Call back sender of message.
 - *SendTxtMsg* » *Sending a written message to an internal caller.*
 - *Savetorep* » Save the sender's number in your directory.
 -  » Terminate consultation.

6.16 Message notification

A message is left in your mailbox but you are not at your desk. You can configure your telephone so that you receive notification of the message on another telephone.

- Reach the 'Menu' page.
- *Settings* › *Notification*
- Press consecutively to activate/deactivate.
- *ON/OFF*
- *Choice* » Press consecutively to activate/deactivate.
- 

6.16.1 Change the time slot

The time slot during which notification is activated can be changed.

- *Schedule*
- Change times.
- 

7 Programming your telephone

7.1 Initializing your voice mailbox

- Light flashes.
- 
- Enter your personal code then record your name according to voice guide instructions.

Your personal code is used to access your voice mailbox and to lock your telephone.

Your password has 6 digits. A weak personal code with 6 identical digits (000000, 111111, etc.) or a simple sequence of 6 digits (012345, 123456, etc.) will be rejected by the system. After a system upgrade, the password may still have only 4 digits. For security reasons, we recommend you use a password with 6 digits. Contact your installer for more information. The list of weak passwords provided does not contain all the possibilities.

7.2 Customizing your voice greeting

You can replace the greeting message by a personal message.

- Reach the 'Menu' page.
- [Settings](#) › [Mailbox](#)
- You can listen to the greeting, customize the greeting and set the default greeting ([Listen](#), [Recordname](#), [Default](#)).
- You can replace the greeting message by a personal message ([Persmessage](#)).
- You can pause, resume or stop the recording at any time.

7.3 Modifying your personal code

- Reach the 'Menu' page.
- [Settings](#) › [Options](#) › [Password](#)
- Old code (6 digits).
- New code (6 digits).
- 



As long as your voice mailbox has not been initialized, personal code is 1515.

Your password has 6 digits. A weak personal code with 6 identical digits (000000, 111111, etc.) or a simple sequence of 6 digits (012345, 123456, etc.) will be rejected by the system. After a system upgrade, the password may still have only 4 digits. For security reasons, we recommend you use a password with 6 digits. Contact your installer for more information. The list of weak passwords provided does not contain all the possibilities.





7.4 Adjusting the audio functions

- Reach the 'Menu' page.
- *Settings* › *Phone* › *Ringing*



7.4.1 Choose the tune

- *Int. Melody/Ext. Melody*
The tune must be chosen for external and internal calls.
- Select the melody of your choice (16 tunes).
- 
-  End.



7.4.2 Adjusting the ringer volume

- *Volume*
-   Select the volume you want: (10 levels).
- 
-  End.



7.4.3 Activate/deactivate silent mode

- *Silent*
- *ON/OFF* ›› activate/deactivate.
- 
-  End.



7.4.4 Activate/deactivate meeting mode (progressive ringing)

- *Progressive*
- *ON/OFF* ›› activate/deactivate.
- 
-  End

7.4.5 Activate/deactivate discreet ring mode

- *Beeps*
- *3 Beeps + Ringing*
- *ON/OFF* ›› activate/deactivate.
- 
-  End.

7.4.6 Adjust ringer volume while a call arrives

- Your telephone rings.
-   Adjusting the ringer volume.



7.5 Adjusting the brightness of the deskphone

Adjust the brightness of the display, the LEDs, the keys (add-on) and the logo light on the back shell (optional).

7.5.1 Auto-adjusting of the brightness

The phone can automatically adjust the display brightness, LED and busy light logo on the back shell (if present) depending on the lighting conditions to improve user experience and achieve power savings (ambient light sensor).







Auto-adjusting of the display brightness

-  or  (long press) › *Display* › *LED brightness auto*
- Activate or deactivate the feature.







Auto-adjusting of the LED brightness and the busy light logo on back shell (if present)

-  or  (long press) › *Display* › *Advanced* › *LED brightness auto*
- Activate or deactivate the feature.







7.5.2 Adjust the brightness when the phone is in use

-  or  (long press) › *Display* › *Brightness*
-   Increase or decrease the brightness.
- 
- 

7.5.3 Adjust the dimmed brightness when the phone is not in use



-  or  (long press) › *Display* › *Advanced* › *Low brightness*
-   Increase or decrease the brightness.
- 
- 

7.5.4 Set the delay before the brightness is dimmed when the phone is not in use (screensaver)

-  or  (long press) › *Display* › *Screensaver*
-   set the time delay (default 4 hours).
- 
- 

7.6 Selecting the welcome page

This function is used to choose the page displayed by default on the telephone.

- *Settings* › *Options* › *Homepage*
- Select the default page (Menu, Perso, Info, Last page seen ...).
- 
- 

7.7 Selecting language



- Reach the 'Menu' page.
- *Settings* › *Options* › *Language*
- Select the language of your choice.
- 

7.8 Programming direct call keys (Perso page/F1 and F2 keys/Add-on module)





Depending on your deskphone, you can program:

- Softkeys of the Perso page.
 - Keys/softkeys of the add-on module.
 - F1 and F2 keys.
 - Programmable keys with LED and paper.
 - Programmable keys with LED and paper.
- Led behavior may differ depending on the system configuration. For more information, contact your installer or administrator.





If the key is not programmed yet:

- Select the key to program.
- *Name*: Enter the name of the key.
- 
- *Number*: Enter the number to associate with the key.
- 
- 



If the key is already programmed:

-  (or *Settings* › *Keys*)
- Select the key to program.
- *Name*: Enter the name of the key.
- 
- *Number*: Enter the number to associate with the key.
- 
- 

7.9 Modifying direct call keys

-  (or *Settings* › *Keys*)
- Select the key to modify.
- *Name*: Enter the name of the key.
- 
- *Number*: Enter the number to associate with the key.
- 
- 
- 

7.10 Deleting direct call keys

-  (or *Settings* > *Keys*)
- Select the key to delete.
- *Clear*
- 

7.11 Programming an appointment reminder

You can set the time of a temporary reminder (one within 24 hours) or a permanent reminder (every day at the same time).

- Reach the 'Menu' page.
- *Appointment*
- Enter time of appointment.
- *Temporary/ Permanent* >> Select the type of appointment (temporary or permanent).
- 

The 'Appointment programmed' icon is displayed on the welcome page.

At the programmed time, your phone rings:

- 

If your calls are forwarded to another terminal, the forward is not applied to the reminder call.

To cancel your reminder request:

- Reach the 'Menu' page.
- *Appointment*
- *Temporary/ Permanent* >> Select the type of appointment (temporary or permanent).
- *Clear*
- 

The 'Appointment programmed' icon disappears from the welcome page.

7.12 Identify the terminal you are on

The number of your telephone is displayed on the 'Info' page.

7.13 Lock / unlock your telephone

 This icon indicates that the phone is locked.

- Reach the 'Menu' page.
- *Lock*
- Enter your password >> Your telephone is locked/unlocked.

7.14 Install a jack accessory (headset, handsfree, loudspeaker)



By default, the audio jack of your telephone can be used to connect a headset, hands-free kit or loudspeaker. A wideband headset can also be installed for optimized sound quality.

When you plug the jack accessory in the jack, a popup asks you for the type of accessory:

- *Headset*
- *Handset*
- *Handsfree*
- *Loudspeaker*

A specific icon is displayed in the status bar: .

If necessary, you can also select the accessory type in the audio settings:

-  or  (long press) **> Audio.**
- *Jack config.*
- *Headset / Handset / Handsfree / Loudspeaker >>* Select the type of device plugged into the jack.
- 

Your phone is equipped with a 3.5 mm, 4 pole jack. If your device is not compatible, you can use an adapter.



7.15 Activating/Deactivating 'Forced headset' mode

- Reach the 'Menu' page.
- *Settings > Phone > ForcedHead*
- *ON/OFF >>* activating/deactivating forced headset.

7.16 Installing a Bluetooth® Wireless Technology handset (pairing)

This feature is only available with compatible Bluetooth® deskphone. Otherwise the corresponding menu is not displayed or is inactive.

Before a Bluetooth® headset can be used, it must be correctly paired to the terminal.

- Use one of the following:
 - 
 -  (long press) **> Bluetooth**
- *Search devices*
-  With the handset turned off, press the 2 Bluetooth® handset keys at the same time (long press).

>> You will hear a 3 note signal and the LED will flash green and orange alternately.

>> Searching for Bluetooth® equipment. Wait for the detected equipment type and address to be displayed.

- Select the relevant equipment: ALE BT Handset.
- *Add*
- Enter the PIN code of the device if necessary. The default password is 0000.
- *Confirm >>* The 3-note tone indicates that the handset has been installed correctly. The LED flashes green or orange depending on the battery charge level.

7.16.1 Error messages

The Bluetooth® handset emits a sequence of 4 beeps	»»	Your set is an older generation than your Bluetooth® handset
The set displays an error message indicating that the set and the Bluetooth® handset are incompatible	»»	Your Bluetooth® handset is an older generation than your set

7.17 Use of the Bluetooth® handset

The Bluetooth® Wireless handset is only available with compatible Bluetooth® phones.

The Bluetooth® cordless handset permits the user to answer and converse with complete freedom within a radius of 10 meter from the set.

The handset has a LED and two buttons.

7.17.1 Switch on/off



- Switch on / off the Bluetooth® handset: long press on the off-hook/on-hook key.

7.17.2 Light

- Green flashing: normal operation.
- Green steady: handset charging.
- Orange flashing: battery charge low or handset outside coverage zone.
- Orange steady: malfunction.

7.17.3 Off-hook/On-hook and Volume/Mute keys



- Off-hook/On-hook: press this key to take or terminate a call.
- Volume/Mute:
 - Short successive presses to change the handset volume level (3 levels).
 - Long press to ensure your caller no longer hears you.

If the Bluetooth® handset is on its base, you do not need to press the Off-hook/On-hook key to take or terminate the call. Just off-hook/on-hook the Bluetooth® handset.

7.18 Installing a Bluetooth® Wireless Technology headset (pairing)

This feature is only available with compatible Bluetooth® deskphone. Otherwise the corresponding menu is not displayed or is inactive.



A multi-point Bluetooth headset can be provided by ALE International.

This headset can be paired to your mobile phone and other communication devices at the same time.

For example, you can use the headset paired to your mobile and when you enter your office the headset automatically matches to your office set too.

You can then answer a call using your Bluetooth headset or the Bluetooth Handset on the office set.

Before a Bluetooth® headset can be used, it must be correctly paired to the terminal. Before performing the pairing operation, the headset must be in detectable mode.

- Use one of the following:
 - 
 -  (long press) › *Bluetooth*
- *Search devices*

›› Searching for Bluetooth® equipment. Wait for the detected equipment type and address to be displayed

- Select the relevant equipment.
- *Add*
- Enter the PIN code of the headset*.
- *Confirm* ›› Acknowledgement message and display of the headset icon on the terminal screen.

*Refer to the user documentation supplied with the headset.



7.19 Using a Bluetooth® Wireless Technology headset

This feature is only available with compatible Bluetooth® deskphone. Otherwise the corresponding menu is not displayed or is inactive.

Refer to the user documentation supplied with the headset.

7.20 Display all paired Bluetooth devices



This feature is only available with compatible Bluetooth® deskphone. Otherwise the corresponding menu is not displayed or is inactive.

- Use one of the following:
 - 
 -  (long press) › *Bluetooth*
- *Devices*

›› Display of the different equipment paired.

7.21 Removing a Bluetooth accessory (headset, handset, etc.)

This feature is only available with compatible Bluetooth® deskphone. Otherwise the corresponding menu is not displayed or is inactive.

- Use one of the following:
 - 
 -  (long press) › *Bluetooth*
- *Devices*

›› Display of the different equipment paired.



- Select the equipment to be removed.
- *Remove*
- 

›› Message acknowledging the equipment has been removed.

7.22 Pair your phone as a Bluetooth device

This feature is only available with compatible Bluetooth® deskphone. Otherwise the corresponding menu is not displayed or is inactive.

Your phone can be used as a Bluetooth device (loudspeaker for example). Before performing the pairing operation, your phone must be in detectable mode.

- Use one of the following:
 - 
 -  (long press) › *Bluetooth*
- *Parameters*

›› Display of the different equipment paired. A specific icon is displayed on the screen .

7.23 Configure your phone for teleworking

Your IP phone is compatible with teleworking (VPN) via a secure connection (encrypted). In this mode, all features available at your office will be ready for use remotely.

If the telephone system of your enterprise is configured to accept remote workers (system and infrastructure), you have to configure your deskphone to be ready for teleworking. Your installer has to give you all information to configure your deskphone.

You have to:

- Enable VPN.
- Enter the remote VPN server information.
- Enter the TFTP server information (optional).
- Enter authentication.
- Setup the VPN start preferences.



7.23.1 First connection as teleworking

When you connect your deskphone for the first time remotely, you are prompted to set a PIN code. The PIN code is requested when you enter in the VPN configuration (submenus) or when you boot your deskphone (depending on the VPN configuration).

The PIN code is retained during the session so that you can access the VPN configuration without having to re-enter your PIN code until you exit the VPN configuration.

Before configuring your phone for teleworking, check if you have all the information from your administrator.

To configure your deskphone:

- Connect your deskphone to the network (and plug in the power jack if you are using an external power adapter).
- When the deskphone displays the 'Step 2' during the boot, repeatedly press the '*' and '#' keys in succession until a menu is displayed.
- **VPN** (Scroll down the menu).
 - **VPN Config**
 - Enter the new PIN Code.
 - Validate.
 - **Enable VPN**: you have to activate this option to use your deskphone for teleworking.
 - **Server**: enter the address of the VPN server.
 - **PSK**: enter the pre-shared key to establish a secure connection with the VPN server. The PSK can be unique for all remote workers on a same installation or can be specific to each remote worker. In the first case, the VPN authentication has to be enabled.
 - **VPN Tftp** › **Use TFTP servers, tftp1, tftp2,port**: if the TFTP servers are required, activate this option and enter the addresses and port of the TFTP servers.
 - **VPN Auth** › **Use Authentication, User, Pass**: activate this option if a logon to the VPN server (username and password) is required. The VPN authentication can be disabled in case a specific PSK is used for each remote worker.
 - **VPN Pincod** › **Request Pin on Boot**: if this option is activated, the PIN code is required when you boot your deskphone. We recommend you activate this option.
 -  Select this icon to return to the main menu.
 - Select this icon to save parameters.
- The VPN configuration is saved and the main menu is displayed.
-  select this icon to exit the configuration menu. The deskphone restarts.
- Enter the PIN code if you have selected the option (**Request Pin on Boot**).
- Validate.
- Your deskphone is ready for teleworking.

If you leave the PIN code request menu when the phone is starting, the phone will start without VPN activated.

7.23.2 Change the configuration

You have to change a parameter of the VPN configuration.

- Restart the deskphone (unplug and plug in the power jack if you are using an external power adapter or the Ethernet connector – LAN).
- When the deskphone displays the 'Step 2' during the boot, repeatedly press the '*' and '#' keys in succession until a menu is displayed.
- *VPN* (Scroll down the menu).
- Select a submenu to change the configuration (*VPN Config, VPN Tftp, VPN Auth, VPN Pincod*).
- Enter your PIN code (if an administrator password is defined by the system, you can use it to access to the VPN configuration by selecting: *Use Password*).
- Validate.
- Change parameters.
- Select this icon to save parameters.
- The VPN configuration is saved and the main menu is displayed.
-  select this icon to exit the configuration menu. The deskphone restarts.
- Enter the PIN code if you have selected the option (*Request Pin on Boot*).
- Validate.
- Your deskphone is ready for teleworking.

7.23.3 PIN code

The PIN code is composed of 4 digits. You can access the VPN configuration by entering the PIN code or the administrator password if defined by the system. Depending on the VPN configuration, the PIN code is requested when you boot your deskphone. We recommend you enable this option for security reasons and if you need your phone in remote and in business place (See Reconnect your deskphone in your business place).



If the PIN code is incorrect 5 times in succession, the PIN code and VPN parameters will be erased. If no administrator password is defined by the system, the PIN code is required to access VPN configuration.

7.23.4 Reset your PIN code

- Restart the deskphone (unplug and plug in the power jack if you are using an external power adapter or the Ethernet connector – LAN).
- When the deskphone displays the 'Step 2' during the boot, repeatedly press the '*' and '#' keys in succession until a menu is displayed.
- *VPN* (Scroll down the menu).
- *VPN Pincod*
- Enter your PIN code.
- Validate.
- *Set new Pincod*: enter the new PIN Code.
- Select this icon to save parameters.
- The VPN configuration is saved and the main menu is displayed.
-  select this icon to exit the configuration menu. The deskphone restarts.
- Enter the PIN code if you have selected the option (*Request Pin on Boot*).

7.23.5 Reconnect your deskphone in your business place

Your phone is already configured for teleworking.

- Connect your deskphone to the network (and plug in the power jack if you are using an external power adapter).
- If the option to enter PIN code when you boot your deskphone is enabled in the VPN configuration (*Request Pin on Boot*):
 - The PIN code is requested.
 -  Select this icon to go back.
 - The phone restarts in normal mode. The VPN is temporary disabled until the next reboot.
- If the option is not enabled:
 - When the deskphone displays the 'Step 2' during the boot, repeatedly press the '*' and '#' keys in succession until a menu is displayed.
 - *VPN > VPN Config*
 - Enter your PIN code.
 - Validate.
 - *Enable VPN*: Disable the teleworker.
 - Select this icon to save parameters.
 - The VPN configuration is saved and the main menu is displayed.
 -  select this icon to exit the configuration menu.
 - The phone restarts in normal mode.

7.23.6 Reconnect your deskphone in remote place

Your phone is already configured for teleworking but it was connected in your place of business. You need to reconnect it in a remote place.

- Connect your deskphone to the network (and plug in the power jack if you are using an external power adapter).
- If the option to enter PIN code when you boot your deskphone is enabled in the VPN configuration (*Request Pin on Boot*):
 - The PIN code is requested.
 - Enter PIN code.
 - Validate.
 - The phone starts as teleworker.
- If the option is not enabled (*Request Pin on Boot*):
 - When the deskphone displays the 'Step 2' during the boot, repeatedly press the '*' and '#' keys in succession until a menu is displayed.
 - *VPN > VPN Config*
 - Enter your PIN code.
 - Validate.
 - *Enable VPN*: Enable the teleworker.
 - Select this icon to save parameters.
 - The VPN configuration is saved and the main menu is displayed.
 -  select this icon to exit the configuration menu.
 - The phone starts as teleworker.

7.24 Contacting your administrator

If necessary you may need to contact your administrator.

Before contacting your administrator make sure you have information such as your phone's part number and software version to hand.

7.24.1 The part number

The phone's part number is located under the foot of the phone.

7.24.2 Software version

The software version can be viewed on the phone by following this path:

- *System* › *Version*:

8 ACD: Agent set/ Supervisor station

8.1 Agent set

A call center solution allows optimum distribution of calls to agents according to their availability and skills.

8.2 Open an agent session (login) – Agent set

- Select the ACD application.
- *Login*
- Select the agent and validate.
- **OK**
- Depending the displayed information, enter your password or confirm.

» ACD application welcome screen is displayed.

8.3 ACD application welcome screen – Agent set

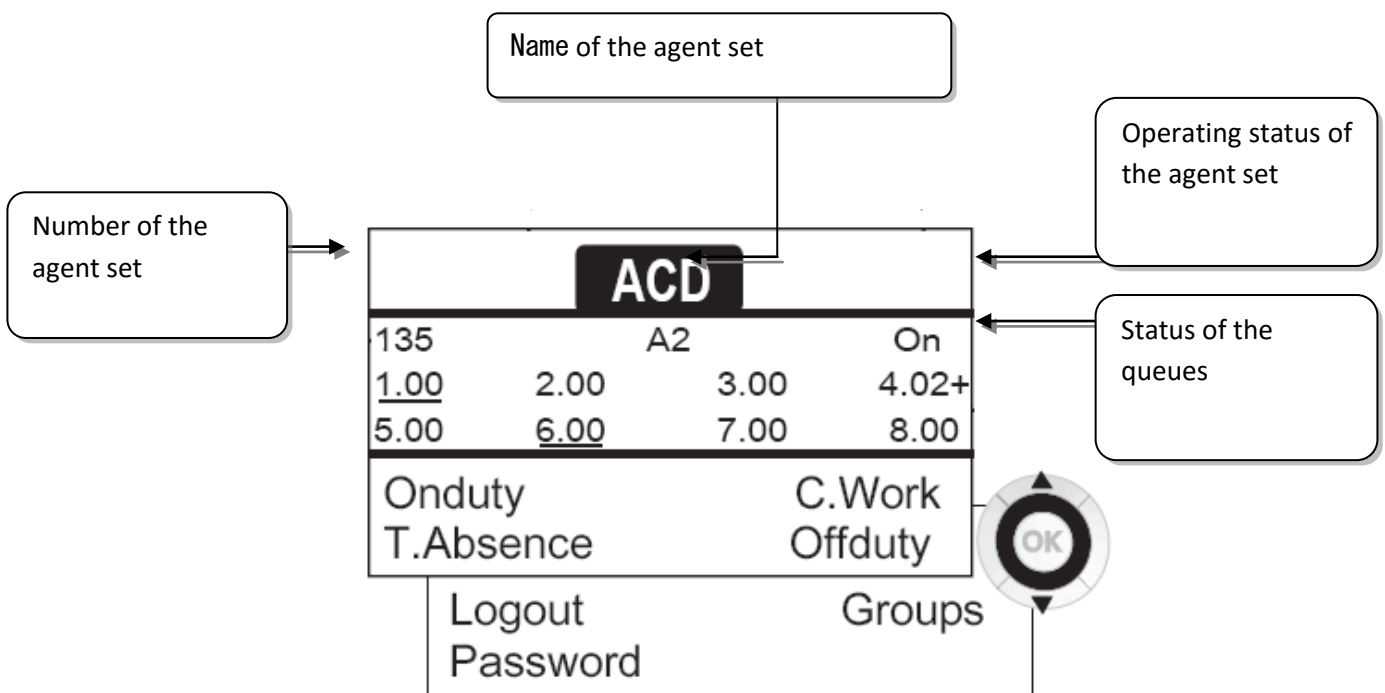

4.02 means: group number 4 / 2 calls waiting / the + sign indicates that the queue capacity has been reached .

8.4 The four operating statuses of the agent set

An agent's availability is determined by the operating status (of which there are 4), that the agent can change at any time. These statuses are:

- *Onduty* >> In service, the agent is ready to receive calls.
- *Offduty* >> Withdrawn, the agent has withdrawn from the ACD application.
- *C.Work* >> Additional task, the agent is performing a task concerning a call and is not taking other calls.
- *T.Absence* >> Temporarily absent, the agent has taken a break and is not taking calls.

The agent can change the operating status directly by entering codes, pressing the function keys, or using the Agent Assistant agent software on PC (if available).

8.5 Changing the operating status of the set – Agent set

8.5.1 Changing using codes (all sets)

The operating status change codes are defined when the system is configured. Contact the system administrator to obtain these codes.

- Enter the feature code to activate.

8.5.2 Change using function keys

- Press the function key of the status to be activated. Information relative to the selected status is displayed on the screen. If a refusal message is displayed, contact the system administrator.

8.6 Modifying your personal code – Agent set

- *Password*
- New code (6 digits).

8.7 Integrating another group/leaving a group – Agent set

- *Groups*
- Press the key of the group (1 to 8) to integrate (box empty) and/or press the key of the group to leave (box full).

8.8 Close the agent session (logout) – Agent set

- *Logout*

8.9 Supervisor station

- A supervisor can consult the messages left in the voicemail inboxes of the call center groups (maximum 8 groups) using the function keys.

A supervisor can also perform the agent function from the same set

8.10 Supervising group mailboxes – Supervisor station

8.10.1 Consulting the messages

When a message is left in a group mailbox, the voice mail present indicator associated with the supervision key flashes.

- Press the supervision key.
- Follow the instructions of the voice guide.

When a mailbox is consulted by a supervisor, the other supervisors cannot access it

8.10.2 Supervision keys for group mailboxes and positioning on the sets

- Access the Perso page to display the positioning of the supervision keys on the sets.

9 Accessories

The ALE-supported accessories are intended to work smoothly on most/all of our clients (hardphones, softphones). The list of accessories presented in this document is not contractually binding and may be modified without prior warning.

9.1 Headsets

9.1.1 Jack 3.5 mm 4-pole corded headset

- Corded Monaural Wideband Headset (Plantronics HW510N 3GV28047AD).
- Corded Binaural Wideband Headset (Plantronics HW520N 3GV28048AD).
- Quick Disconnect to Jack 4 poles, pack of 10 items (Plantronics, 3GV28177AB).
- Corded Premium Monaural Wideband Headset (Sennheiser SC 232 3GV28047BA).
- Corded Premium Binaural Wideband Headset (Sennheiser SC 262 3GV28048BA).
- Jack Monaural Headset (Plantronics C215 3BN78155AA).
- Easy Disconnect to Jack 4 poles (Sennheiser CMB 01 CNTRL).



9.1.2 USB headset

- USB Binaural Headset (Plantronics C325-1 3GV28057AB).
- Quick Disconnect to USB adapter (Plantronics DA45 → DA80 3GV28178AA).
- Corded Premium Monaural Wideband Headset (Sennheiser SC 232 3GV28047BA).
- Corded Premium Binaural Wideband Headset (Sennheiser SC 262 3GV28048BA).
- Corded Premium Binaural Wideband Headset (Sennheiser SC 260 USB CNTRL II 3GV28057BA).
- Easy Disconnect to USB adapter (Sennheiser USB-ED CC 01).



9.1.3 Bluetooth headset

- Bluetooth Monaural Headset (Plantronics Voyager Legend 3BN67215WW).
- Bluetooth Binaural Headset (Plantronics Voyager Focus).
- Bluetooth Binaural Headset (Sennheiser MB Pro 2 UC 3GV28066BA).



9.2 Conference module

- Alcatel-Lucent 8125 Audiooffice usb.

9.3 EHS interface

- External ringing interface module (MWS 3GV28050AA).

10 Guarantee and clauses

10.1 Safety Instructions

- Changes or modifications to the equipment not expressly approved by the party responsible for compliance could void the user's authority to operate the equipment.
- Magnets could affect the functioning of pacemakers and implanted heart defibrillators. Keep a safe distance between your pacemaker or implant defibrillator and the handset which includes magnetic elements: 4 centimeters (1,6 inches) at least.
- To limit the risk of interference, people with pacemakers must keep the wireless telephone away from their equipment (minimum distance of 15 cm/6 inches).
- It is recommended to follow the standard acceptance procedures before using this equipment in human safety critical areas (hospitals...).
- The handset includes magnetic elements that may attract sharp metallic objects. To prevent injury, before each use ensure sharp metallic objects are not stuck to the earpiece and microphone.
- A Bluetooth Handset with integrated battery is available with certain Product variants. The battery must be charged during 6 hours before initial use and must be replaced correctly to prevent danger of explosion. Use only the recommended battery. Contact your Business Partner if you need a spare battery.
- Avoid using phones (other than cordless type) during an electrical storm. There may be a remote risk of electric shock from lightning.
- Do not use the device in environments where there is a danger of explosion.
- Do not plug this phone into an Integrated Services Digital Network (ISDN) connection or into a regular Public Switched Telephone Network (PSTN) connection. This can result in severe damage to the phone.
- Never allow your telephone to come into contact with water.
- To clean your telephone, use a soft damp cloth. Never use solvents (trichlorethylene, acetone, etc.) which may damage the plastic parts of your telephone. Do not use aerosol cleaners.
- This product is intended to be supplied, either via the Ethernet (LAN) port, or via the DC-in by a Certified Direct Plug-In Power Unit approved as 'LPS' (Limited Power Source) against CSA/UL/IEC 60950-1 and rated 48V dc, minimum 0.27A. Allowed power supplies: WA-13B48R – Asian Power Devices Inc.
- Some Premium DeskPhones and Smart DeskPhones also offer a Bluetooth® radio interface for Bluetooth® handsets or other Bluetooth® devices frequency range 2402-2480 MHz, radiated power 5 mW.
- If you are connected to a POE connection do not use an external Power Supply.
- The cover of the phone screen is made of glass. This glass could break if the phone is dropped or it receives a significant blow. If the glass chips or cracks, stop using the phone and do not touch the broken glass as this could cause injury to you. Glass cracked due to misuse or abuse is not covered under the warranty.

10.2 Regulatory Statements

EUROPE

This equipment is in compliance with the essential requirements of directives 1999/5/EC (R&TTE), 2014/53/EU (RED), 2014/30/EU (EMC), 2014/35/EU (LVD), 2009/125/EC (ErP) and 2011/65/EU (RoHS) Declaration of Conformity may be obtained from: ALE International 32 avenue Kléber – 92700 Colombes, France

ebg_global_supportcenter@al-enterprise.com

USA and Canada

Phones with Bluetooth comply with Industry Canada's license-exempt RSSs. Operation is subject to the following two conditions: (1) this device may not cause harmful interference, and (2) this device must accept any interference received, including interference that may cause undesired operation. This equipment has been tested and found to comply with the limits for a class B digital device, pursuant to Part 15 of the FCC Rules. These limits are designed to provide reasonable protection against harmful interference in a residential installation. This equipment generates, uses and can radiate radio frequency energy and, if not installed and used in accordance with the instructions, may cause harmful interference to radio communications. However, there is no guarantee that interference will not occur in a particular installation. If this equipment does cause harmful interference to radio or television reception, which can be determined by turning the equipment off and on, the user is encouraged to try correcting the interference by consulting the dealer.

Exposure to Radio Frequency Signals.

This equipment complies with radiation exposure limits set by FCC/IC and the Council of European Union for an uncontrolled environment. This equipment has very low levels of RF energy and is deemed to be compliant without testing of the specific absorption rate (SAR).

User Instructions

Use this product in temperatures between -5°C to +45°C (23°F to 113°F).

This product is intended for use in an indoor environment only. This apparatus is Hearing Aid Compatible (HAC).

Acoustic shock protection

Maximum sound pressure level for handset is compliant with European, US and Australian standards.

Directive 2003/10/EC specifying the risks inherent in noise at work

The ring contributes towards overall daily noise - at its maximum setting, the level is 105 dBA at 60 cm from terminal. To reduce the level, the following is recommended:- reduce the setting (9 levels of 5 dB) - program a progressive ring.

Privacy

Privacy of communications may not be ensured when using the Bluetooth® handset or any additional Bluetooth® device.















Disposal

















The equipment must be returned to a collection point for electronic equipment waste disposal. Defective batteries must be returned to a collection point for chemical waste disposal.









Related Documentation







Other languages for these Safety and Regulatory Instructions and User Documentation are available at the following Web site: <http://enterprise.alcatel-lucent.com?product=All&page=Directory>.





The information presented is subject to change without notice. ALE International assumes no responsibility for inaccuracies contained herein. Copyright© ALE International 2017.

Features keys	
Mute and intercom.	
Handsfree, handset or headset volume. Adjust contrast.	 
Audio services (handsfree, handset or headset).	
<ul style="list-style-type: none"> Programmable keys (F1 and F2 keys): Lit when the function associated with the key is activated. A service or a direct call can be associated to these keys. Pre-programmed function keys are disabled in 'safe ' mode. The F1 and F2 keys are line keys. 	
Redial key: to access the 'Redial' feature.	
Quick access to user local menu (long press). Used to obtain information on functions of the 'menu' page and to program key of the 'perso' page (short press).	
Messaging key to access various mail services. This key is lit when you have received a new voicemail, text message or callback request.	
Handsfree key To make or answer a call without lifting the receiver.	
END key To terminate a call.	
Bluetooth® wireless handset (Compatible Bluetooth deskphone)	
Off-hook/On-hook.	
Volume/Mute: <ul style="list-style-type: none"> Short successive presses to change the handset volume level (3 levels). Long press: Contains your caller no longer hears you. 	
Welcome screens	
<p>You can access all of your phone's features from these screens. The default display has three pages that you can access by pressing to the page tabs at the top of the screen. The selected page is highlighted.</p> <ul style="list-style-type: none"> Menu page: Contains all functions and applications accessible via the keys associated with the words on the screen. Perso page: Contains call line keys (allowing supervision of calls) and programmable call keys. Info page: Contains information on the telephone and the status of its functions: name, telephone number, number of messages, activation of transfer function, appointment reminder, etc. 	
	<p>Manage your call forwarding by pressing the forward icon.</p> <ul style="list-style-type: none"> Stationary arrow: No forwarding activated. Blinking arrow: Forwarding activated.

Touchscreen navigation			
	Select a page by pressing the corresponding tab on the screen. The selected page is highlighted. Make your selection by pressing the label on the screen.		
	Scroll a list (features, call log, contact, ...) by pressing the up and down arrow on the screen, or on the keyboard.		
	Use the 'OK' softkey to validate your choices and options while programming or configuring.		
	Use the 'Back/Exit' icon to go back to the previous step.		
	Use the 'Setting' icon for quick access to the user local menu.		
	Use the 'Bluetooth' icon to open Bluetooth settings.		
Navigation keys			
	<ul style="list-style-type: none"> OK key: Use to validate your choices and options while programming or configuring. Left-right navigator: Use to move from one page to another and display information about current calls (call in progress, calls on hold, incoming call). Up-down navigator: Use to scroll through the content of a page. 		
	<ul style="list-style-type: none"> Use this key to go back to the previous step. Use this key to go back to the homepage (long press). 		
Status icons/ Call icons			
	Headset connected.		Incoming call icon.
	Telephone locked.		Call in progress icon.
	Appointment programmed.		Call holding icon.
Alphabetic keypad		User local menu	
Cursor moving keys (left, right, up and down).		 or  (long press): Open the user local menu. The user local menu depends on the type of the set. The user local menu lets you: <ul style="list-style-type: none"> Configuring the audio jack of your telephone. Adjusting the brightness of the deskphone. Activate/deactivate the logo on back shell. Installing a Bluetooth® Wireless accessory. Display all paired Bluetooth devices. Removing a Bluetooth accessory (headset, handset, etc.). Use your DeskPhone as a Bluetooth audio accessory. Change the theme (skin) of your phone. 	
Caps lock: to write text in capital letters.			
Alt key: to access the purple characters and features.			
Enter key: to validate edited text.			
Backspace key: to delete one character in an edit box.			

Call Dial the number directly or dial the number after pressing a line key (an off-hook key phone or Bluetooth handset, hands-free key).	
Call by name (Company directory) Enter the first letters of contact's name and follow the on-screen instructions.	
Answer a call Take the handset off the hook, use an off-hook key (phone or Bluetooth handset), use the hands-free key, or press the incoming call icon.	
Ignore call / End the call.	
Redial Long press to access the list of the last 10 dialed numbers. Short press to call the last dialed number.	
Make a call-back request to a busy number <i>Callback</i>	
Placing a call on hold (hold) <i>Hold</i>	
Sending DTMF signals <i>MFcode</i> Send numbers.	
Mute	
Interphony The phone automatically answers the call. Before the line is taken, you hear a succession of specific beeps.	
Making a second call during a conversation <i>New call</i>	
Answering a second call during a conversation. Select the incoming call icon.	
Switching between calls (Broker call) Select the call on hold icon from the conversation screen.	
Cancel your second call You automatically recover the first call.	
Transferring a call You are in conversation with one caller. Call a second contact. <i>Transfer</i>	

Conference Call the first contact. Call the second contact. <i>Conference (Conf).</i>	
Make calls via your programmed call keys Press the desired programmed call key.	Perso
Programming direct call keys Press the 'I' key or <i>Settings > Keys</i> Select the key to program. Enter the name and number to associate to the key.	Menu 
Modify the programmed key Press the 'I' key or <i>Settings > Keys</i> Press the programmed key to be modified. Follow the on-screen instructions.	Menu 
Erase a programmed key Press the 'I' key or <i>Settings > Keys</i> Select the key to be erased. Follow the on-screen instructions.	Menu 
Customizing your voice greeting <i>Settings > Mailbox</i> You can listen to the greeting, customize the greeting and set the default greeting.	Menu
Consulting your voice mailbox	
Diverting calls to your voice mailbox Select the forward icon. <i>Immediate VM</i> Select the type of call forwarding required.	
Cancel forward Select the forward icon. <i>Cancellwd.</i>	

Do not disturb Select the forward icon. <i>DoNotDisturb (DND)</i>	
Send text messages <i>Message</i> <i>SendTxtMsg</i> Enter the destination number. Select the type of message to send (fixed Msg, New Msg,...).	
Read text messages <i>Message</i> <i>ReadTxtMsg</i>	
Information about the phone	Info
Lock/unlock the phone <i>Lock</i>	Menu
Adjust audio volume	
Select the language of your choice <i>Settings > Options > Language</i>	Menu
Choose the tune <i>Settings > Phone > Ringing</i> Adjust the ring via the following menus: Melody, Silent, Beeps, Volume, etc.	Menu
Adjust the brightness of the set Press the 'I' key > <i>Display > Brightness</i>	
Modify the password for your phone set <i>Settings > Options > Password</i>	Menu
Homepage <i>Settings > Options > Homepage</i> Select the default page.	Menu